



Parking Area Noise

6. Revised Edition

Recommendations for the Calculation of Sound
Emissions of Parking Areas, Motorcar Centers and
Bus Stations as well as of Multi-Storey Car Parks
and Underground Car Parks

Environment **Subject**

Imprint

Parkplatzlärmstudie – 6. revised edition

ISBN 3-936385-26-2

Editing:

Möhler + Partner, Beratende Ingenieure für Schallschutz und Bauphysik,
Paul-Heyse-Str. 27, 80336 München
Tel.: (0 89) 54 42 17-0
Fax: (0 89) 54 42 17-99
E-Mail: info@mopa.de
Internet: <http://www.mopa.de>
Project performance:
Dipl.-Ing. Manfred Liepert
by cooperation of
Dipl.-Ing. FH Rudolf Liegl, Dipl.-Ing. Ulrich Möhler, Martin Nunberger,
Dipl.-Ing. FH Gerhard Prestele

Instruction and Edition:

Bayerisches Landesamt für Umwelt
Bürgermeister-Ulrich-Straße 160, 86179 Augsburg
Tel.: (08 21) 90 71-0
Fax: (08 21) 90 71-55 56
E-Mail: poststelle@lfu.bayern.de
Internet: <http://www.bayern.de/lfu>
Project management:
Dipl.-Ing. Wolfgang Hendlmeier
by cooperation of
Dipl.-Geogr. Stefan Bauer, Dipl.-Ing. Wolfgang Fürst, Hubert Gail,
Dipl.-Phys. Peter Pelikan, Dipl.-Ing. FH Bernhard Ruttka,
Dipl.-Phys. Dr. Alfons Schmalzbauer, Dipl.-Ing. Heinz Sonntag,
Dipl.-Phys. Reiner Tröbs und Dipl.-Phys. Wolfgang Vierling

Translation:

Dr. Alfons Schmalzbauer, Bayer. Landesamt für Umwelt

Financing:

Bayerisches Staatsministerium für Umwelt, Gesundheit und
Verbraucherschutz, München

Layout:

Mediendesign Sporer, Am Backofenwall 3, 86153 Augsburg

Printing:

Bayerisches Staatsministerium für Umwelt, Gesundheit und
Verbraucherschutz; Rosenkavalierplatz 2, 81925 München
August 2007

Citing (proposal):

Bayer. Landesamt für Umwelt (editor): Parkplatzlärmstudie 6. Aufl.,
Augsburg 2007

Bayerisches Landesamt für Umwelt (LfU) is part of the area of responsibility of the Bayerisches
Staatsministerium für Umwelt, Gesundheit und Verbraucherschutz (StMUGV)

© Bayerisches Landesamt für Umwelt, Augsburg, August 2007
All rights reserved. Reprint and reproduction – also in part – is allowed with the permission of the
publisher only.

Contents

Preface		7
Chapter 1 Introduction		9
1.1	Fundamentals	9
1.2	Important Amendments in Comparison with the 5. Edition	9
1.3	Instruction for Using	10
Chapter 2 Tasks and Plan of Inquiry		11
Chapter 3 Review of the Inquiries and Sound Level Measurements		13
3.1	Moving Processes on Parking Areas (Traffic Censuses)	13
3.1.1	Selection of the Probe Sites	13
3.1.2	Performances of the Examinations – Inquiry Parameters	14
3.1.3	Transposition to Reference Values for the Description of the Ascertained Vehicle Motions	14
3.2	Sound Level Measurements	15
3.2.1	Source Level Measurements	17
3.2.2	Measurements on Underground Car Park Ramps and near Multi-Storey Car Parks	17
3.2.3	Controlling Measurements	18
Chapter 4 Evaluation Method		19
4.1	Evaluation Method for Inquiries	19
4.2	Evaluation Method for Sound Level Measurements	19
Chapter 5 Examinations of Vehicle Motions on Parking Areas		21
5.1	P + R Areas	22
5.2	Parking Areas of Filling and Recreation Stations	26
5.3	Parking Areas and Underground Car Parks near Housing Areas	29
5.4	Parking Areas near Discotheques	30
5.5	Parking Areas near Purchase Markets	32
5.6	Parking Areas near Restaurants	36
5.7	Parking Areas near Hotels	44
5.8	Parking Areas near Pubs and Inns	46
5.9	Open-for-All Parking Areas and Multi-Storey Car Parks in City Centres	48
5.10	Additional Examinations for the Registration of Further Affecting Parameters	50

5.10.1	Motion Frequency's Dependence on Weekdays, Parking Area Type Pub or Inn	50
5.10.2	Motion Frequency's Dependence on the Carports' Distance to the Entrance of a DIY Store	50
5.10.3	Examinations of the Vehicle Motions near the Filling Station of a Purchase Market	51
5.10.4	Examinations of the Vehicle Motions near a Discotheque, Differentiated with Respect to Spezial Discotheque Carports and Other Carports	51
5.10.5	Examinations of the Vehicle Motions near a Restaurant, Differentiated with Respect to Special Restaurant Carports and Other Carports	52

Chapter 6 Sound Level Measurements 53

6.1	Source Level Measurements of Parking Processes	53
6.1.1	Motorcars, Motorcycles and Delivery Vans of up to 2.8 t of Permissible Total Weight	53
6.1.2	Lorries of more than 2.8 t of Permissible Total Weight and Busses	58
6.2	Measurements for the Determination of the Influence of Different Surfaces on the Driving Lanes	61
6.3	Measurements near the Ramps of Underground Car Parks	62
6.3.1	Measurements' Results near not Enclosed Ramps of Underground Car Parks	64
6.3.2	Measurements' Results near Enclosed Ramps of Underground Car Parks	66
6.3.2.1	Underground Car Park Ramps with Reflecting Walls	66
6.3.2.2	Underground Car Park Ramps with Absorbing Walls	67
6.4	Measurements near Multi-Storey Car Parks	68

Chapter 7 Details of Sound Emission Calculation 71

7.1	Parking Areas	71
7.1.1	Fundamentals of the Calculation Method	71
7.1.2	Passaging Traffic Share in Case of the Integrated Method	71
7.1.3	Separated Calculation Method	73
7.1.4	Surcharges for Impulse Character (K_I)	74
7.1.5	Surcharges for the Parking Area Type (K_{PA})	75
7.1.6	Surcharges for Different Surfaces on the Driving Lanes (K_{StrO} and K_{StrO}^*)	76
7.2	Underground Car Park Ramps	76
7.2.1	General Remarks	76
7.2.2	Approaching and Leaving Traffic, Traffic on not Enclosed Ramps	77
7.2.3	Sound Emission through Open Garage Gate in Case of Enclosed Ramp	78
7.2.4	Passing over a Rain Gutter	79

7.2.5	Opening or Closing a Garage Roller Gate	80
7.3	Multi-Storey Car Parks	80
Chapter 8	Recommended Calculation Method for the Sound Engineering Forecast	83
8.1	General Remarks	83
8.2	Parking Areas at Ground Level	87
8.2.1	Normal Case (So-called Integrated Method)	87
8.2.2	Special Case (So-called Separated Method)	88
8.2.2.1	Partial Emissions of Entering and Leaving a Carport without Passing Traffic	89
8.2.2.2	Partial Emissions of Traffic Searching for a Carport and of Passing-Through-Traffic	89
8.3	Underground Car Parks	89
8.3.1	Approaching and Leaving Traffic, Traffic on not Enclosed Ramps	90
8.3.2	Sound Emission through Open Garage Gate, of Entering and Leaving Traffic, in Case of Enclosed Underground Car Park Ramp	91
8.3.3	Passing over a Rain Gutter	91
8.3.4	Opening or Closing a Garage Roller Gate	92
8.4	Multi-Storey Car Parks	92
8.4.1	Sound Power Level Determination of the Parking and Passing-Through Expanses per Parking Storey	92
8.4.2	Determination of the Indoor Sound Level per Parking Storey	93
8.4.3	Determination of the Radiated Sound Power Levels	94
8.4.4	Sound Propagation Calculation	94
8.4.5	Maximum Noise Levels	94
Chapter 9	Comparison of Calculation Results with Controlling Measurements Results	95
9.1	Controlling Measurements	96
9.2	Comparison of the Rating Level Measurements with the Calculations	99
Chapter 10	Sound Engineering Assessment of Parking Areas and Other Facilities of the Stationary Traffic in Germany	100
Chapter 11	Recommendations for Planning in View of Sound Protection	101
11.1	General Remarks	101
11.2	The Traffic Surroundings of the Parking Area and the Arrangement of Carports and Entrances	102
11.3	Sound Protection Measures	103

Chapter 12 Annex	104
Annex 1: Abbreviation Index	104
Annex 2: Example of the Sound Engineering Calculation of a Parking Area	105
Annex 3: Example of the Sound Engineering Calculation of an Underground Car Park Entrance	108
Annex 4: Example of the Sound Engineering Calculation of a Multi-Storey Car Park	117
Annex 5: Measurement Results of Busses, Partial Processes During Parking Motions	121
Annex 6: Measurement Results of Entering and Leaving Motorcars at the Tested Underground Car Park Ramps	122
Annex 7: Measurement Results at the Tested Multi-Storey Car Parks During Simulated Parking Processes	123
Annex 8: Remarks	124
Annex 9: Acts, Regulations, Literature	129
Annex 10: Figures` Dictionary	133

The documentation of the motion and occupancy paces of all tested parking areas can be obtained from Büro Möhler+Partner, Paul-Heyse-Strasse 27, 80336 München (fee: 15 EUR).

Preface

The noise and air pollution exposure due to the road traffic is generally known. But together with the flowing traffic also the so-called stationary traffic is growing, that is the demand for parking spaces and facilities, and so are the sound immissions caused by the use of them. Two examples shall illustrate this: The large parking areas of the numerous new purchase markets at the city peripheries are often accompanied by noise problems due to the approaching and parking traffic. Also the parking areas near stations, for years built in order to support the split traffic of the private motorcars on the one hand and railways, tramways and subways on the other hand, can induce annoying sound immissions in the neighbouring housing areas. Thus before the assent resp. plan approval of the facilities of the stationary traffic, the expected sound immissions have to be forecasted and assessed according to noise control acts.

Formerly the sound emissions of parking areas were calculated according to DIN 18005, part 1 (edition of May 1987) "Schallschutz im Städtebau" ("Noise Control in Urban Development"), as a rule. This calculation method was principally practicable. There was, however, evidence that the parameters were not fixed sufficiently. Moreover in the DIN 18005 different types of parking areas and their geometric shapes were not taken into account. Criteria for the specific volume of traffic (e.g. the vehicle motions per carport and hour) were missing, too.

Therefore since 1984 the former Bavarian State Agency for the Environmental Protection (LfU) (since August 2005 incorporated into the newly established Bavarian State Agency for the Environment) has conducted preliminary investigations for a "survey about parking area noise" and in 1986 has commissioned the examinations of sound emissions of parking areas, car centers and bus stations to the Dorsch Consult Ingenieures. mbH. The survey was finished in 1988 and published in 1989, i.e. the 1st edition of the so called "Parking Area Noise". In the 2nd (1993) and die 3rd edition (1994) the calculation method was fitted more and more to the real situation. Later the complete new editing, which was published as 4th edition in 2003, was delayed because of several difficulties.

For many years the updating of the parking area noise study has been deriving benefit from the close relations between users and editor. After the 5th edition's appearance, the amended formula for the consideration of the passaging traffic share in the case of the integrated calculation method was discussed vividly because of the calculated rating levels' accuracy being too high, and therefore it was developed newly for a smaller forecast's accuracy.

The important amendments of the 6th edition in comparison with the 5th edition are given in section 1.2.

When the parking area noise survey was published in 1989, it could not be foreseen that the included method for calculating sound emissions from parking areas would gain such a widespread dissemination: so it was incorporated, in a more elementary form for the sound engineering calculation of public parking areas, into the "Richtlinien für Lärmschutz an Straßen (RLS 90)" ("Guidelines for the Noise Protection at Roads"). Moreover it is partly used like a regulation by the noise immission protection agencies and engineering offices in Bavaria and many other federal states for the sound engineering calculation of private parking areas. Moreover, internationally widespread sound engineering calculation programs have implemented the investigation of sound emissions according to this study, and that's why it is also known in the non-German-speaking foreign countries.

The updated version of DIN 18005-1 "Schallschutz im Städtebau" from July 2002

is referring to the parking area noise study explicitly in sections 2 and 7.1. In a way it even entered the regulations in the neighbouring countries. In this connection it has been proven that complaints of neighbours about the operation noise of parking areas don't occur at all if the method of calculation and assessment described in the study has been used. Though as a rule, for formally juristic reasons, it is not utilized in Germany in the case of parking areas converted according to street legislation.

May the present 6th edition have a widespread dissemination among experts. If nothing else, I want to thank everybody who contributed to it or gave precious informations as a user.

A handwritten signature in black ink, appearing to read 'Albert Göttle', written in a cursive style.

Prof. Dr.-Ing. Albert Göttle
President

1 Introduction

Editing: Bavarian State Agency for the Environment

1.1 Fundamentals

The administrative procedures for planning according to the Baugesetzbuch ("Federal Building Code"), the Bundes-Immissionsschutzgesetz (BImSchG) ("Federal Immission Control Act"), the Landesbauordnungen ("Building Regulations of the Federal States") or those within the scope of Planfeststellungsverfahren ("Plan Approval Procedures") have to regard also the stationary traffic and its sound immissions in the neighbouring residential areas. Part of the stationary traffic are parking areas for motorcars and lorries, petrol stations and resting places, central bus stations etc. In the case of longitudinal and cross parking tracts as well as parking bays in public traffic spacings as a rule the sounds of the flowing traffic are dominating. Hence the noises of vehicles entering and leaving the parking tracts of public roads are not regarded separately as a rule. In special cases such parking areas must be calculated according to [5].

Important results of the parking area noise study were integrated in a calculation method for public parking areas later (RLS-90, section 4.5 [5]), though not the data about the expected single acoustic incidents (maximum levels), as the respectation of maximum levels – in addition to the equivalent levels – is not established in the rules of traffic noise abatement for financial reasons. Moreover, from the view of noise protection and in order to simplify the regulations it would be desirable not to make a distinction between public and private parking areas (also compare section 10.1).

1.2 Important Amendments in Comparison with the 5. Edition

Since 1990 the parking area noise study is utilized by the sound immission protection agencies and engineering offices in Bavaria, in other federal states and – in a modified way – for part even in the neighbouring countries. In this connection it has proved that complaints of neighbours about the operation noise of parking areas don't rise at all when the method of calculation and assessment described in the study has been used and the immission reference values of the Technische Anleitung zum Schutz gegen Lärm – TA Lärm [2] ("Federal German Noise Regulation – TA Lärm") are not exceeded.

The 6th edition of the parking area noise study differs from the 5th edition of 2006 by three important amendments:

1. In the case of the separated calculation method, for the plane-specific sound power level's calculation not any more K_1^* has to be taken but K_1 like in the case of the integrated calculation method (cp. sect. 7.1.4).
2. The formula (3) for the consideration of the passaging traffic and the traffic searching for carport, introduced in the 3rd edition, was amended. After extensive test calculations a new formula (3) was developed whose results in the case of small and medium size parking areas are deviating only less from those which are ascertained with the formula introduced in the 3rd edition. Moreover, the new formula's

scope is reaching also for parking areas with any number of carports, this means also for parking areas with more than 150 carports. In the case of larger parking areas, the old formula yielded results being obviously too high.

3. The surcharge K_{PA} for parking areas with asphalted driving lanes, on which low noise shopping trolleys are shuffled, is 3 dB(A), like in the case of standard trolleys.

1.3 Instruction for Using

Chapter 8 of the 6th edition of the "Parking Area Noise Study" presents the recommended calculation method for the sound engineering forecast of parking areas, motorcar centers and bus stations as well as underground car parks and multi-storey car parks; the preceding chapters present the determination of the input quantities and the calculation method's derivation. Chapter 9 compares the controlling measurements' results of parking areas with the rating levels calculated according to chapter 8. Chapter 10, which deals with the sound engineering assessments exclusively in Germany, is edited out in the english edition. Chapter 11 gives recommendations for planning in view of the sound protection and thus supplements the Recommendations for Facilities of the Stationary Traffic – EAR 91 [11] with supplementations [33] ff.. To what extent the relatively few counting results can yet be regarded as sufficient in view of sound engineering forecasts, cannot be estimated reliably at present. For time considerations and financial reasons, however, further inquiries must be reserved to subsequent projects. In tab. 33 for sound engineering forecasts "on a safe position" the maximum vehicle motions found out per reference value's unit (f.e. carports' number) and hour are indicated as basic quantities. From that should be deviated to lower inputs only in justified exceptional cases. Lower counting results on particular parking areas are listed in tab. 4 – tab. 12.

The publication of the "Parking Area Noise Study" is a paper of the LfU documents, showing only some typical motion and occupancy paces of the examined parking areas. The examination's complete motion and occupancy paces are summarized in a special materials' volume [37].

Amendments in comparison with the 5. edition

2 Tasks and Plan of Inquiry

The essential amendments of the present 5th edition in comparison with the 4th edition of the parking area noise study are scheduled in section 1.2 .

The parking area noise study's fundamental basic approach is to provide a suitable calculation method for the determination of parking areas' sound *emissions*. Therefore, among other things, per parking area type typical vehicle motions are quantified as well as metrologically determined sound emissions are shown per vehicle and parking area type. On the basis of the sound emissions, determined according to the calculation methods termed in the parking area noise study, the sound *immissions* originating in private parking areas can be calculated according to the conditions of the Federal German Noise Regulation – TA Lärm of August 1998 (sound propagation calculation according to DIN ISO 9613-2 [9])¹.

The tasks for the complete revision of the parking area noise study's 3rd edition is repeated here once more in an abridged version:

- inquiries of vehicle motions on different parking area types,
- sound level measurements of motorcar, motorcycle, delivery van, truck and bus motions on parking areas for the update of the sound emissions' qualification of parking processes,
- sound level measurements on the ramps of underground car parks and near multi-storey car parks as a basis of a calculation proposal for these parking area types,
- sound level measurements on several parking area types for the proposed calculation method's check,
- check and, if necessary, revision of the formulas of the sound emission's calculation.

Due to informations of users of the parking area noise study's 4th edition, for the 5th edition the amendments and supplementations described in section 1.2 were developed. The former Bavarian State Agency for the Environmental Protection charged the Büro Möhler + Partner with the examinations for the parking area noise study's 4th and 5th edition; the bureau was acting according to the following investigation schedule:

1. Preparation of the examination:

- sighting of the present-day literature,
- selection of the probe sites.

2. Performance of the on-site investigations:

- vehicle motions' inquiries on different parking area types
 - complementary inquiries on the parking area types examined already before 1994 (P+R area, purchase market, underground car park near a residential district, discotheque and public parking area) in order to enlarge the data stock,
 - inquiries of vehicle motions on the, up to now not yet examined on-site, parking area types filling and recreation station, restaurant and hotel (in [30] for these parking area types only assumptions on theoretical ideas were made).
- sound level measurements on parking areas
 - sound level measurements of motorcar, motorcycle, delivery van, truck and bus motions on parking areas for the update of the sound emissions' qualification of parking processes,

- sound level measurements on the ramps of underground car parks and near multi-storey car parks as a basis of a calculation proposal for these parking area types,
- sound level measurements on several parking area types for the proposed calculation method's check.

3. Evaluation of inquiries and sound level measurements

4. Presentation of the results in the inquiry report

3 Review of the Inquiries and Sound Level Measurements

3.1 Moving Processes on Parking Areas (Traffic Censuses)

Tab. 1 gives an overview of all inquiries of vehicle motions on parking areas which were performed within the scope of the parking area noise study. In addition to the total number of inquiries performed between 1984 and 2005, the number of inquiries performed between 1999 and 2005 is shown.

As shown in tab. 1, the prevailing part of the inquiry data originates from current investigations in the period from 1999 to 2005.

Parking area type	Number of inquiries	
	Total number 1984 - 2005	Inquiries 1999 - 2005
P + R area	16	4
Filling and recreation station	6	6
Underground car park near residential district	9	5
Discotheque	9	7
Purchase market	36	31
Restaurant	13	13
Hotel	7	7
Pub / Inn	6	6
Parking area and multi-storey car park in city centre	3	2
All examined parking areas	105	81

Tab. 1:
Review of the vehicle motions' inquiries on parking areas in the period from 1984 to 2005

3.1.1 Selection of the Probe Sites

The preselection of suited probe sites was done based on extensive sightseeings and examinations before the censuses. The final sample of the probe sites was specified on-site together with the former Bavarian State Agency for the Environmental Protection. Thereby the fixing of suitable probe sites proved to be difficult and expensive; f.e. the probe sites had to be representative for the respective parking area type and the inquiries' conditions had to be taken into account when selecting the probe sites (parking motions and approaching and leaving traffic should be visible, if possible, from one spot etc.).

During the investigations it became clear that the originally planned scale of the inquiries had to be extended in view of a complete revision of the parking area noise study and in view of the objective target to gain inquiry data as representative as possible. Despite of the abovementioned difficulties, based on the extensive sightseeings in the further progression of the examinations additional suited probe sites could be found.

On two P + R areas, which had been examined already in 1986, renewed countings were made for the comparison with the conditions present in 1999. Concerning the countings near purchase markets and discounters performed in the years 2004 and 2005, when choosing the parking areas it was respected that such parking areas were chosen as well which had been tested already in 1999. With this, among others a compari-

son shall be made possible which reflects the influence of the opening hours extended since then.

3.1.2 Performances of the Examinations - Inquiry Parameters

The inquiries per parking area type were made in those periods when the maximum frequency of vehicle motions could be expected (f.e.: for P + R areas as well as for filling and recreation stations on Tuesday to Thursday, for discotheques normally on Friday night, for purchase markets normally on Saturday, for discounters on days with special offers etc.). The inquiries` periods can be learnt individually from the synoptical tables 4 ff..

For the parking area types filling and recreation station, purchase market, underground car park near a residential district, discotheque, restaurant and hotel the inquiries were announced in before; at this additionally relevant inquiry data of the probe sites were found out.

The following inquiry parameters were recorded per investigation site during the on-site investigations:

- date of inquiry (date/ day of the week / time period of inquiry),
- total number of carports,
- number of the approaching and leaving traffic processes,
- outline of probe site with carports` positions,
- number of the vehicle motions attributed to the object of investigation, differentiated with respect to approaching and leaving traffic for each half an hour (on vehicle motion = one approaching or leaving event),
- number of maximally occupied carports within the inquiry period (partly difficult to see on-site; therefore additional arithmetical investigation via approaching and leaving traffic),
- additional inquiry parameters, dependent on the parking area type (f.e. net selling area and shop hours for purchase markets),
- further notes and background informations (among others informations of the staff in the case of restaurants, hotels, discotheques).

3.1.3 Transposition to Reference Values for the Description of the Ascertained Vehicle Motions

The reference of the moving frequency to the number of carports has proved to be not proper in the case of purchase markets and discotheques, because thus operators providing a generous carports` offer to their clients are discriminated possibly. More proper in the case of the parking area types purchase market, restaurant, discotheque and hotel, following the guidelines of the governmental carport rules (f.e. [12]), seems to be a reference to the following characteristic parameters:

- discotheque: net restaurant room,
- purchase market: net selling area,
- restaurant: net restaurant room (resp. number of seats),
- hotel: number of spare beds (resp. number of spare rooms).

The net restaurant room comprises the area of the restaurant rooms without consideration for the areas of service rooms like kitchens, toilettes, corridors, store rooms and the like. The net selling area analogously comprises the areas of selling rooms without consideration for the areas of service rooms like toilettes, store rooms, offices, but also minus the areas of corridors and of the cash area ⁷¹⁾ .

Definiton of the terms
"net restaurant room"
and "net selling area"

For the inquiry results` presentation (vehicle motions/reference value and hour) these characteristic parameters were determined for each probe site respectively. Doing that, the collecting of the required data showed to be difficult and timeconsuming, because the data had to be obtained on a governmental way. According to the data protection acts the called inquiry data are represented in an anonymized way.

In view of a quantification of further parameters of influence, the following additional inquiries were performed within the scope of the investigation themes:

- parking area type inn:
exemplary inquiries of the vehicle motions on two different days of investigation (on workdays/weekend) for the determination of the influence of different weekdays.
- parking area type purchase market:
 - exemplary inquiries of the vehicle motions on a DIY superstore`s parking area depending on the carports` distance to the entrance resp. exit,
 - exemplary additional inquiries of the vehicle motions near a filling station belonging to the purchase market.
- parking area types restaurant and discotheque:
respectively exemplary inquiries of the vehicle motions, differentiated with respect to the carports provided by the operator and other carports, e.g. longitudinal carports along the road or neighbouring parking areas.
- parking area type filling and recreation station:
separate counting of the motions near the filling station and near the resting place resp. vehicles stopping at both the filling stations and the resting place.

In section 4.1 the inquiries` evaluation methods are described. The explanation of the inquiries` results as well as their documentation in a tabular and graphic form follow in chapter 5.

3.2 Sound Level Measurements

Table 2 gives an overview of the sound level measurements performed between 1999 and 2005 within the scope of the parking area noise study`s revision.

For the present investigation the results of the measurements performed in 1986 were called on for comparison`s purposes. Yet they were not integrated into the measurement data as the vehicle fleet measured at that time is out-of-date since then.

In the following the performed measurements are described briefly and the measuring concept and the measurements` objective target are explained. In section 4.2 the measurements` evaluation methods are described; from chapter 6 the measurements` results can be learnt particularly. The detailed description of the sound level measurements by means of site plans, outlines, exemplary sound level-to-time-courses and tables of results can be found also in chapter 6.

The following measurement devices were used for the sound level measurements:

- calibrated precision sound level meter Brüel + Kjaer 2231 with stroke maximal module,
- calibrated precision sound level meter Brüel + Kjaer 2233,
- calibrated sound level analyzer CEL 573.A1,
- calibrated sound level analyzer Neutrik-Cortex NC 10,
- acoustic calibrator Brüel + Kjaer 4231,
- Sony DAT measuring data recorder PC208Ax with conditioning unit M978 (for sinus signals, 8 channels each),
- DAT-recorder Sony TCD 7,
- Sound Level Analyzer Brüel + Kjaer 2146,
- calibrated integrating sound level meter Rion NL-31,
- acoustic measuring system Soundbook with software application SAMURAI.

The measuring signals were recorded digitally on a DAT tape resp. on a data medium for each probe site and the parameters relevant for the sound level measurements were documented in the measurement report.

Tab. 2:
Review of the sound level measurements performed in the period between 1999 and 2005

Sort of sound level measurements	Number of probe sites
Sound emission measurements:	
- P + R area: motorcar, delivery van, motorcycle (including simulation of different parking area types)	1
- Lorry operating center	2
- Busstation	1
Measurements on u nderground c ar p ark ramps and near multi-storey car parks:	
- U. c. p. with open ramp	2
- U. c. p. with enclosed ramp, not faced on the inside in an absorbent manner	3
- U. c. p. with enclosed ramp, faced on the inside in an absorbent manner	1
- Open multi-storey car park 2)	2
- Car park with a storey	1
Controlling measurements:	
- P + R area	2
- Purchase market	1
- Discotheque	1
Total	17

3.2.1 Source Level Measurements

For an update of the sound emissions occurring during parking processes, sound level measurements of vehicles of the present vehicle fleet were performed.

The sound emissions` measurements of motorcars, motorcycles and delivery vans took place on two measuring dates in July and November of 1999 on a P + R area in Munich. Complete parking processes could be measured because the processes of entering and leaving a carport were simulated with vehicles provided therefore specifically. The former strategy of adding discrete partial processes to one parking process arithmetically was not pursued any more with these vehicle classes.

With the following vehicles sound level measurements were performed during simulated processes of entering and leaving a carport:

- 7 motorcars (6 with gasoline engines, 1 with a diesel engine),
- 3 motor-cycles (2 with four-stroke engines, 1 with a two-stroke engine),
- 2 delivery vans (1 with a gasoline engine, 1 with a diesel engine; total weight ≤ 2.8 tons each).

The chosen vehicles represent a typical cross section of the present vehicle fleet; the vehicles` years of construction were varying from 1990 and 1999. The detailed vehicle parameters are listed in the emission measurements` result tables (tables 18 and 19).

The emission measurements of parking processes of trucks and busses (total weight > 2.8 tons) took place in June of 1999 on a truck operating center and in July of 1999 on a busstation. No complete parking processes could be simulated during these measurements. Instead of this typical partial processes like door bashing, accelerated departure, starting the engine etc. were measured individually.

Hence in 2005 additional measurements of complete parking processes were performed near a truck operating center in Wörth. To that specifically the drivers of trucks of an up-to-date construction type were requested to perform a truck`s parking process at a measuring point chosen before.

Measurements of the following vehicles were performed:

- 2 truck trailers ($> 7,5$ tons),
- 6 articulated lorries ($> 7,5$ tons).

3.2.2 Measurements on Underground Car Park Ramps and near Multi-Storey Car Parks

As a basic proposal for the sound engineering calculation of underground car parks and multi-storey car parks the following sound level measurements were performed on the ramps of underground car parks and near multi-storey car parks:

- In order to compare underground car parks with an "enclosed" and with an "open" ramp metrologically (enclosed – not enclosed), altogether four underground car parks in Munich were chosen.

The sound level measurements took place near two underground car parks with an

“open” ramp in June of 1999, the measurements near two underground car park ramps with an “enclosed” ramp in the period of June/July of 1999. Near the examined underground car parks one measuring point was set opposite to the ramp and one lateral to the ramp, respectively. The further description of the sound level measurements on the ramps of underground car parks is shown in section 6.3.

- Near the underground car parks with an enclosed ramp moreover the efficiency of an absorbing paneling of the interior walls was checked metrologically. To that, in July of 2005 near two enclosed underground car park ramps of comparable dimensions (with reference to slope and profile) measurements during simulated entering/leaving processes were performed. There one of both underground car park ramps was faced in an absorbent manner on the inside, whereas the other ramp was faced in a reflecting manner on the inside (concrete cover).
- For the noise engineering inquiries near multi-storey car parks, two “open” multi-storey car parks and one car park with a storey were chosen. In the following, as “open” will be designated all those multi-storey car parks which are characterized by the parking noises` radiation in the multi-storey car park through mostly open lateral faces. As the open coverage type of multi-storey car parks makes possible a cost-efficient ventilation and deaeration, this type as a rule is used. The sound level measurements near the chosen multi-storey car parks were performed in the period of June/July of 1999. For a simultaneous recording of the parking noises inside the multi-storey car parks and outside the radiating lateral faces, microphones were positioned inside and outside the car parks, respectively. The further description of the sound level measurements near multi-storey car parks is shown in section 6.4.

3.2.3 Controlling Measurements

In order to check the proposed calculation method, controlling measurements were performed near the parking area types P + R area, purchase market and discotheque.

The sound level measurements took place in the period from June to November of 1999, lasting about 3 hours each and the measurement duration time being fixed for each probe site to the maximum frequency of vehicle motions expected.

The positioning of the microphones was chosen in that way that on the one hand the total sum of the noises emitted from the parking area (parking processes, through traffic, partly shopping trolleys, partly conversations of discotheque visitors) could be recorded metrologically and on the other side the influence of other background noises could be kept negligible. Running parallel to the sound level measurements, the number of the vehicle motions was registered. The further description of the controlling measurements is shown in chapter 9.

4 Evaluation Method

4.1 Evaluation Method for Inquiries

On the basis of the on-site ascertained investigations of vehicle motions on parking areas, on the one side the frequencies of motions (vehicle motions/reference value and hour) were determined for the periods relevant in a sound engineering way. On the other side the inquiry data were evaluated in terms of motion and occupancy paces.

The following evaluations were performed for each probe site:

- Determination of the frequencies of motion (vehicle motions/reference value ³⁾ and hour) for the following periods relevant in a sound engineering way ⁴⁾:
 - day 06 a.m.– 22 p.m.
 - night 22 p.m.– 6 a.m.
 - loudest hour at night (full hour at night from 22 p.m. to 6 a.m., see also [2], section 6.4)
- Motion and occupancy paces : graphic representations of the vehicle motions` temporal (every half an hour) distribution as well as of the degree of occupancy in the inquiry period for all probe sites. There the occupancy paces refer to the maximum number of simultaneously occupied carports found in the inquiry period.

The explanation of the inquiries` results as well as their documentation in a tabular and graphic form is shown in chapter 5. Due to the large number of probe sites, the description of the inquiry locations is made not any more (like in the 3rd edition of the study of 1994) based on site plans, but in the form of synoptical tables (see also table 4 ff.) for each parking area type. Therein characteristic data about the inquiry locations are listed [information about geographical site, reference values, number of carports, maximum occupancy on the inquiry date, partly number of approaching traffic events, inquiry date (date, day of the week, period of time), further remarks etc.] and the inquiries` results are shown in the shape of vehicle motions per reference value and hour during the relevant periods of time.

4.2 Evaluation Method for Sound Level Measurements

The signal courses and measuring reports recorded during the noise level measurements were evaluated in the laboratory. The not weighted sound pressure, recorded digitally for each measuring position, was subjected to an A-weighted frequency rating and a FAST-time weighting. The recordings` allocation to the documented parking events was made on the basis of the measuring reports. Partly the measured noise levels of singlevehicle motions already were stored in the noise level measuring devices on-site. In that case the first laboratory evaluation was made with a software specialized to the respective noise level measuring device.

The following measured quantities were recorded for each measurement resp. parking process:

L_{AFeq}	A-weighted equivalent level, time weighting „Fast“
L_{AFmax}	A-weighted maximum level, time weighting „Fast“
L_{AFTeq}	A-weighted equivalent level (stroke maximal level method), time weighting „Fast“
T_M	measurement duration

Based on the measurement duration and the measured equivalent levels, for discrete vehicle motions resp. single partial processes the equivalent levels per hour were determined as follows:

Formula 1
$$L_{AFeq,1h} = L_{AFeq} + 10 \lg (T_M / T_0) \text{ dB(A); with: } T_0 = 1 \text{ h}$$

here is:

$L_{AFeq,1h}$ A-weighted equivalent level per hour, time weighting „Fast“

and

Formula 2
$$L_{AFTeq,1h} = L_{AFTeq} + 10 \lg (T_M / T_0) \text{ dB(A); with: } T_0 = 1 \text{ h}$$

here is:

$L_{AFTeq,1h}$ A-weighted equivalent level per hour (stroke maximal level method), time weighting „Fast“.

The measurements` results of discrete vehicle motions resp. partial processes were averaged energetically for each event separately (e.g. a fixed vehicle`s parking process or partial process, e.g. accelerated departure of a truck). Through this for each vehicle resp. class of vehicles the sound emission`s characteristic parameter “equivalent level per hour” was determined *at the respective measuring point*.

In a further step of evaluation the respective sound power of one parking movement (= approaching or leaving) per hour was determined in consideration of the guidelines of the DIN ISO 9613-2 [9], on the basis of the equivalent level per hour and vehicle resp. class of vehicles and on the basis of the measurements` conditions recorded in the measuring report:

L_{Weq} equivalent sound power level of one parking movement per hour
Exemplary level-to-time-graphs (pictures 17 and 18) demonstrate the on-site conditions.

The further processing and compilation of the measurements` results was made with the help of the EDP progammms “IMMI” [27] and “Excel”; for plotting the diagrams above all the EDP progammms “Origin” and “Famos” were used.

5 Examinations of Vehicle Motions on Parking Areas

In the present inquiry one vehicle motion resp. *parking movement* is defined as one approaching or leaving process including shunting, door shutting etc.; i.e. one entire parking procedure with approaching and leaving corresponds to two parking movements. With it the sound power level of one vehicle motion is less by 3 dB(A) than that of one parking procedure. The occupancy of a parking area is the total number of vehicles parking on the parking area resp. in the parking building in a certain moment.

In chapter 5 the inquiries' results are represented and interpreted for the examined types of parking areas. The probe sites are described in synoptical tables based on the most important inquiry parameters and the individual inquiries' results (among others frequencies of motion: vehicle motions per reference quantity and hour during the periods of measurement relevant in a sound engineering way) are listed tabularly. For the inquiries' results' further presentation, for each type of parking areas typical motion and occupancy paces are indicated.

In the case of the parking area types purchase market, restaurant, discotheque and hotel the inquired vehicle motions were not any more referred to the number of carports. For these types of parking areas, within the framework of the motion frequencies' inquiry the following reference quantities were considered: net restaurant room, net selling area resp. number of spare beds (look at explanation in section 3.1.3).

In order to be on the safe side, for the parking area types P + R area, underground car park near residential district, open-for-all (public) parking area and multi-storey car

Definition of vehicle motion, parking movement, parking procedure

Reference quantity of the frequency of motion in the case of the parking area types purchase market, restaurant, discotheque, hotel is not the carport.

Parking area type	Average number of carports	Unit of the reference value B_0	Average value of the reference value B	Average ratio of the carports/ B_0 (rounded)
Discotheque	216	1 m ² net restaurant room	427 m ²	0,50 carports/ 1 m ² net restaurant room
Consumer market	141	1 m ² net selling area	2039 m ²	0,07 carports/ 1 m ² net selling area
Self-service department store	610	1 m ² net selling area	8631 m ²	0,07 carports/ 1 m ² net selling area
Discounting market	84	1 m ² net selling area	731 m ²	0,11 carports/ 1 m ² net selling area
Shop for electrical supply	54	1 m ² net selling area	1500 m ²	0,04 carports/ 1 m ² net selling area
Market spec. for construction and furniture supplies	155	1 m ² net selling area	5058 m ²	0,03 carports/ 1 m ² net selling area
Hotels	51	1 bed	113 beds	0,50 carports/bed
Restaurants	45	1 m ² net restaurant room	192 m ²	0,25 carports/ 1 m ² net restaurant room
Other parking areas (P + R areas, employees' parking areas and the like)	.	1 carport	.	.

Tab. 3: Average ratio of the carports' number to the reference quantities net selling area, net restaurant room and spare bed

vehicles are parking on faces that are not supposed to this) is detected. In these cases the frequency of motion was not normalized to the maximum number of parking vehicles, but to the number of the marked carports.

In view of recommendations for those frequencies of motion which should be used for the forecasts in a sound engineering way, the found out average and maximum frequencies of motion are indicated in the parking area types` respective synoptical tables 5). The spezial cases having appeared during the inquiries are mentioned and their transmissibility to the forecast is discussed.

The motion and occupancy paces of all inquiries are listed in [37].

Tab. 3 is terming the reference quantities for the several parking area types as well as the found out average values of the reference quantities and the ratio of the carports to the reference quantity. With this it allows to compare the quantities of carport guidelines (cf. e.g. [12]) with the actual proportions.

5.1 P+R-Areas

As can be seen in Tab. 4, altogether 16 inquiries at 14 free of charge P + R locations were performed.

The examined P + R areas were classified in the following subgroups:

- distance to city centre less than 20 km,
- distance to city centre more than 20 km,
- P + R areas in the Rhein-Main area,
- P + R areas of the Deutsche Bahn AG, regional railways.

To sum up, the following inquiries` results at P + R areas can be seen:

- Near the P + R areas in Poing and Grafrath, already investigated in 1986, by comparison new censuses were performed in 1999. In this connection an increase of the vehicle motions by about 15% resp. about 30% during the day time (6 a.m. – 22 p.m.) was found out; during the night (22 p.m. – 6 a.m.) near the P + R area Grafrath a decrease of the motions by about 5% could be listed. A comparison of the results of the night period near the P + R area Poing is not possible, as in 1986 the inquiry was incomplete.
- For the abovementioned subgroups different average and maximum frequencies of motion (motions per carport and hour) were found out. Near the investigated P + R areas at the stations for the regional railways of the Deutsche Bahn AG the relatively topmost frequencies of motion can be seen, the relatively least can be seen near the P + R areas of the S-Bahn in a distance of over 20 km to the city centre.
- In the subgroup “distance to city centre less than 20 km” the motion frequencies of the probe site P + R area Planegg, inquired particularly during the day time, clearly lie above the average of this subgroup.
- A maximum frequency of motion of 0.29 resp. 0.30 motions per carport and hour was found out during the day time (6 a.m. – 22 p.m.) together near three probe sites in different groups of parking areas. During the night (22 p.m. – 6 a.m.) a maximum frequency of motion of 0.10 motions per carport and hour was found out, during the loudest hour at night a frequency of 0.49 was found out. The loudest hours at night were found out to be the hours between 22 and 23 p.m. resp. between 5 and 6 a.m..

Examinations of Vehicle Motions on Parking Areas

Tab. 4:
Inquiries' results near
P + R areas

Inquiry probe site	Number of carports	Number of approaches	Max. occupancy on inquiry date	Inquiry date			Distance to city centre in km	Total number of movements		Motions per carport and hour ⁶⁾ related to max. occupancy				
				Date	Week-day	Time		Day 6a.m.-22p.m.	Night 22p.m.-6a.m.	Day 6a.m.-22p.m.	Night 22p.m.-6a.m.	Loudest hour at night		
Distance to city centre less than 20 km														
P + R area Planegg ⁷⁾	141	2 approaching (=leaving)	141	05.06.84	Tu.	5.30 - 24.00	13	656	30	0.29	0.04	0.02 0.16	5 - 6 22 - 23	
P + R area Gauting	168	2 a. (=l.)	125	01.07.86	Tu.	5.45 - 1.00	17	238	12	0.12	0.01	0.05 0.01	5 - 6 22 - 23	
P + R area Poing 1986	145	1 a. (=l.)	143	08.07.86	Tu.	6.00 - 24.00	19	377	-	0.16	-	0.03	22 - 23	
P + R area Poing 1999	145	1 a. (=l.)	141	09.06.99	Wed.	5.00 - 24.00	19	434	31	0.19	0.03	0.07 0.10	5 - 6 22 - 23	
P + R area Eichenau	271	2 a. (=l.)	271	10.11.87	Tu.	5.30 - 1.00	17	723	81	0.17	0.04	0.11 0.04	5 - 6 22 - 23	
P + R area Olching	129	1 a. (=l.)	137	10.11.87	Tu.	5.30 - 1.00	18	351	11	0.17	0.01	0.01 0.04	5 - 6 22 - 23	
<i>Average</i>										0.18	0.03	0.05 0.06	5 - 6 22 - 23	
Distance to city centre more than 20 km														
P + R area Petershausen	Approx. 500	1 a. (=l.)	443	01.08.84	Wed.	5.00 - 1.00	32	1115	161	0.16	0.02	0.23 0.03	5 - 6 22 - 23	
P + R area Grafrath 1986	168	1 a. (=l.)	131	03.07.86	Thu.	5.00 - 24.00	31	287	21	0.14	0.02	0.08 0.06	5 - 6 22 - 23	
P + R area Grafrath 1999	212	1 a. (=l.)	148	08.06.99	Tu.	5.00 - 24.00	31	371	20	0.16	0.02	0.06 0.03	5 - 6 22 - 23	
P + R area Maisach	260	2 a. (=l.)	257	10.11.87	Tu.	5.30 - 1.00	24	508	60	0.12	0.03	0.12 0.01	5 - 6 22 - 23	
P + R area Holzkirchen	182	2 approaching + 2 leaving	182	10.11.87	Tu.	4.45 - 1.15	30	472	75	0.16	0.05	0.32 0.05	5 - 6 22 - 23	
<i>Average</i>										0.15	0.03	0.16 0.04	5 - 6 22 - 23	
P + R areas in the area of Rhein-Main														
P + R area Eppstein	164	No data	151	24.11.87	Tu.	5.00 - 24.00	21	693	27	0.29	0.02	0.09 0.04	5 - 6 22 - 23	
P + R area Kronberg	256	1 a. (=l.)	158	25.11.87	Wed.	5.30 - 24.00	13	451	19	0.18	0.01	0.01 0.04	5 - 6 22 - 23	
P + R area Groß-Karben	198	1 a. (=l.)	203	26.11.87	Thu.	5.30 - 24.00	14	419	95	0.13	0.06	0.43 0.01	5 - 6 22 - 23	
<i>Average</i>										0.20	0.03	0.18 0.03	5 - 6 22 - 23	
P + R areas Deutsche Bahn AG, Regionalbahn														
P + R area Gessertshausen	145	1 a. (=l.)	115	26.10.99	Tu.	5.00 - 24.00	77	556	28	0.30	0.03	0.13 0.08	5 - 6 22 - 23	
P + R area Moosburg	51	1 a. (=l.)	53	04.05.00	Thu.	5.00 - 24.00	53	189	42	0.23	0.10	0.49 0.24	5 - 6 22 - 23	
<i>Average</i>										0.27	0.06	0.31 0.15	5 - 6 22 - 23	

- no motions during the inquiry's period.

- It could be seen, though statistically not provided security for, that the occupancy has reduced drastically after introducing parking fees. The motorcar drivers for parking used either still receptive neighbouring roads, leading to neighbours' complaints, or they approached the next free of charge parking area or they not any more used the S-Bahn. Cf. also section 8.1.

In fig. 1 typical motion and occupancy paces for this type of parking area are shown with the example P + R area Poing. The motion and occupancy paces of all examined P + R areas are listed in [37].

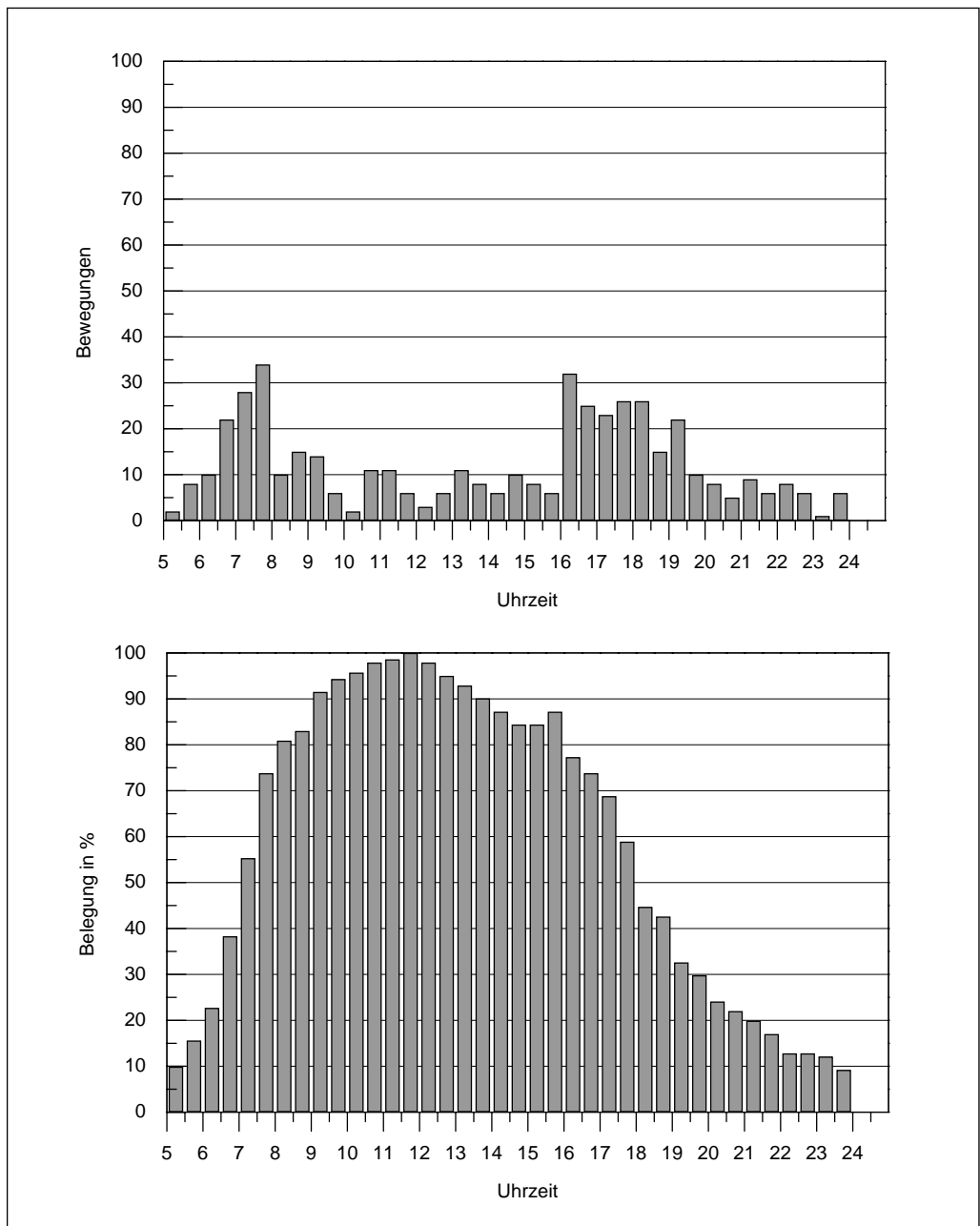


Fig. 1:
Motion and occupancy
pace near the P + R area
Poing, inquiry on
Wednesday, 09.06.1999

Examinations of Vehicle Motions on Parking Areas

Tab. 5:
Inquiries` results near filling and recreation stations

Filling and recreation station, zone												
Inquiry probe site	Inquiry date			Total number of filling movements		Motions per hour ⁶⁾						
	Date	Weekday	Time	Day 6a.m. – 22p.m.	Night 22p.m. – 6a.m.	Day 6a.m. – 22p.m.	Night 22p.m. – 6a.m.	Loudest hour at night				
								4 – 5a.m.	5 – 6a.m.	22 – 23p.m.	23 – 0p.m.	
Höhenrain Ost Motorcar Lorry	16.11.04	Tu.	4.00 – 24.00	266 100	18 20	16.63 8.25	2.25 2.50	0 4	10 8	8 0	0 0	
Lechwiesen Süd Motorcar Lorry	18.11.04	Thu.	4.00 – 24.00	344 38	40 2	21.50 2.38	5.00 0.25	2 0	0 2	4 0	10 0	
Donautal West Motorcar Lorry	23.11.04	Tu.	4.00 – 24.00	510 162	58 48	31.88 10.13	7.25 6.00	8 14	28 6	6 0	0 0	
Allgäuer Tor West Motorcar Lorry	25.11.04	Thu.	4.00 – 24.00	242 64	24 2	15.13 4.00	3.00 0.25	4 0	6 2	6 0	0 0	
Samerberg Süd Motorcar Lorry	30.11.04	Tu.	4.00 – 24.00	222 54	22 0	13.88 3.38	2.75 0.00	0 0	2 0	8 0	4 0	
Fürholzen Ost Motorcar Lorry	02.12.04	Thu.	4.00 – 24.00	578 144	98 0	36.13 9.00	12.25 0.00	12 0	12 0	8 0	14 0	
<i>Average</i>				<i>Motorcar Lorry</i>		22.53 5.86	5.42 1.50	4.33 3.00	9.67 3.00	6.67 0.00	4.67 0.00	

Filling and recreation station, zone "recreation"														
Inquiry probe site	Number of carports	Max. occupancy on inquiry date	Inquiry date			Total number of movements recreation		Motions per carport and hour ⁶⁾ related to the max. occupancy resp. to the carports` number in case of overcrowding						
			Date	Weekday	Time	Day 6a.m. – 22p.m.	Night 22p.m. – 6a.m.	Day 6a.m. – 22p.m.	Night 22p.m. – 6a.m.	4 – 5a.m.	5 – 6a.m.	22 – 23p.m.	23 – 0p.m.	
Höhenrain Ost Motorcar Lorry	25 30	7 17	16.11.04	Tu.	4.00 ñ 24.00	734 138	68 8	(6.55) 0.51	(1.21) 0.06	(0.86) 0.12	(1.43) 0.00	(2.29) 0.12	(1.14) 0.00	
Lechwiesen Süd Motorcar Lorry	60 25	31 45	18.11.04	Thu.	4.00 ñ 24.00	1386 566	166 82	2.79 1.39	0.67 0.41	0.52 0.16	0.97 0.40	0.71 0.48	0.71 0.64	
Donautal West Motorcar Lorry	55 25	32 40	23.11.04	Tu.	4.00 ñ 24.00	870 598	124 102	1.70 1.50	0.48 0.51	0.38 0.72	1.13 1.12	0.69 0.80	0.31 0.00	
Allgäuer Tor West Motorcar Lorry	50 35	13 27	25.11.04	Thu.	4.00 ñ 24.00	728 300	70 46	3.50 0.69	0.67 0.21	0.92 0.30	1.38 0.22	0.77 0.59	0.15 0.00	
Samerberg Süd Motorcar Lorry	50 40	23 64	30.11.04	Tu.	4.00 ñ 24.00	744 598	96 116	2.02 0.93	0.52 0.36	0.26 0.10	0.70 0.55	1.39 0.85	0.43 0.40	
Fürholzen Ost Motorcar Lorry	80 40	45 68	02.12.04	Thu.	4.00 ñ 24.00	1388 722	218 106	1.93 1.13	0.61 0.33	0.40 0.10	0.44 0.40	0.80 0.45	0.80 0.50	
<i>Average</i>				<i>Motorcar Lorry</i>		3.08 1.03	0.69 0.31	0.56 0.25	1.01 0.45	1.11 0.55	0.59 0.26			

in () These high values arise from the small max. occupancy of the parking area. They are disregarded.

5.2 Parking Areas of Filling and Recreation Stations

Censuses of the frequencies of motion were performed at altogether 6 filling and recreation stations near federal motorways. The selection of the filling and recreation stations was especially conformed to the architecture today usual, with filling station and kiosk shortly behind the entrance and with one parallel driving line leading to the recreation station situated behind the filling station. Moreover only one exit from the motorway as well as one entrance into the motorway was allowed to be there in order to make possible the censuses with a sustainable effort. The inquiries` results are listed in Tab. 5.

In the case of the filling and recreation stations the motions at the filling station and the motions at the recreation station were inquired. Within the area of the filling station, apart from the time reference, no further reference quantity is indicated. Within the area of the recreation center 1 carport serves as reference quantity.

Vehicles stopping at the recreation station after visiting the filling station were attributed to the filling station as well as to the recreation station. For a uniform depiction, one vehicle motion at a filling station is represented by one approaching or by one leaving movement. One filling process consequently consists of 2 movements (approaching and leaving). Likewise was proceeded for the recreation station. One vehicle approaching the filling station, leaving it again, approaching the recreation station end leaving it again was consequently inquired with 2 movements at the filling station and with 2 movements at the recreation station. Generally motorcar and truck motions were differentiated in these inquiries.

It could be seen that the vehicle motions per carport and hour, found out within the framework of this study, lie clearly above the values termed in [5], Tab. 5. There is made no difference between motorcar and truck motions either. From the view of the sound protection, in the future the censuses` results (mean values) published here should be used for the sound engineering calculation of filling and recreation stations. These are independent of the used assessment method.

To sum up, the following results can be seen at the investigated filling and recreation stations:

- Within the area of *the filling station* during the day the motions` mean value for motorcars amounts 22.53 motions per hour, that of trucks 5.86 motions per hour. The maximum value amounts 36.13 motions per hour for motorcars, for trucks 10.13 motions per hour. The loudest hours at night are more likely in direction of the early morning hours (5 a.m. – 6 a.m.). The average number of motions at night amounts 5.42 motorcar motions and 1.5 truck motions ; the maximum value of the loudest hour at night amounts 28 motorcar motions and 14 truck motions. The results` distribution range is very large particularly within the area of the filling stations at night.
- Within the range of the *recreation station the motions` daytime mean value* of motorcars amounts 3.08 motions per carport and hour, that of trucks 0.69 motions per carport and hour. The maximum value for motorcars was found at the recreation station Höhenrain. This high value arises however only from the recreation station`s small occupancy in maximum. For the reference values` determination therefore the value 3.5 motions per carport and hour at the recreation station Allgäuer Tor West is used as operative.
- Within the area of the *recreation station the motions` mean value at night* of motorcars amounts 0.69 motions per carport and hour, that of trucks 0.31 motions per carport and hour. The loudest hour at night is in the time from 22 p.m. to 23 p.m..

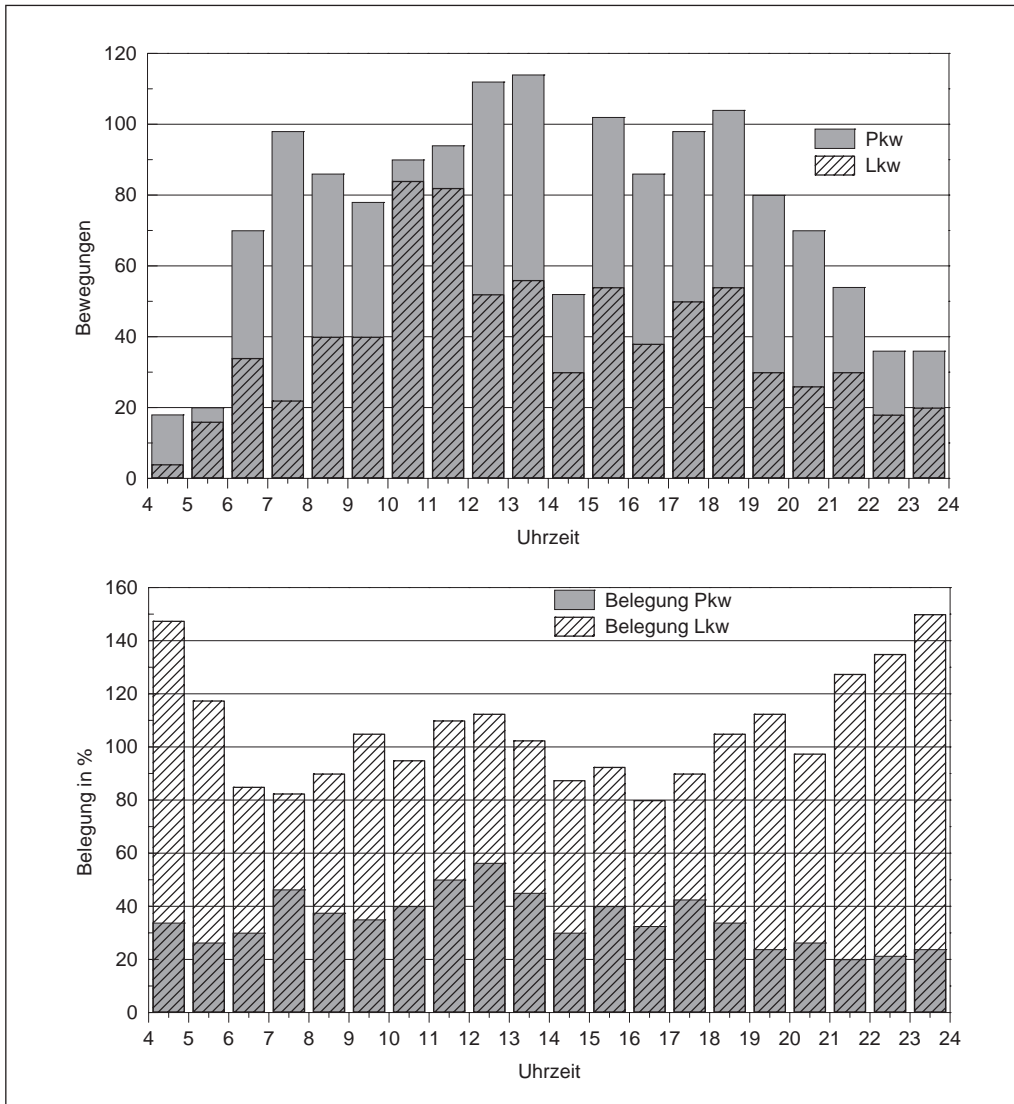


Fig. 2: Motion and occupancy pace near the recreation station Fürholzen Ost, inquiry on Thursday, 02.12.2004

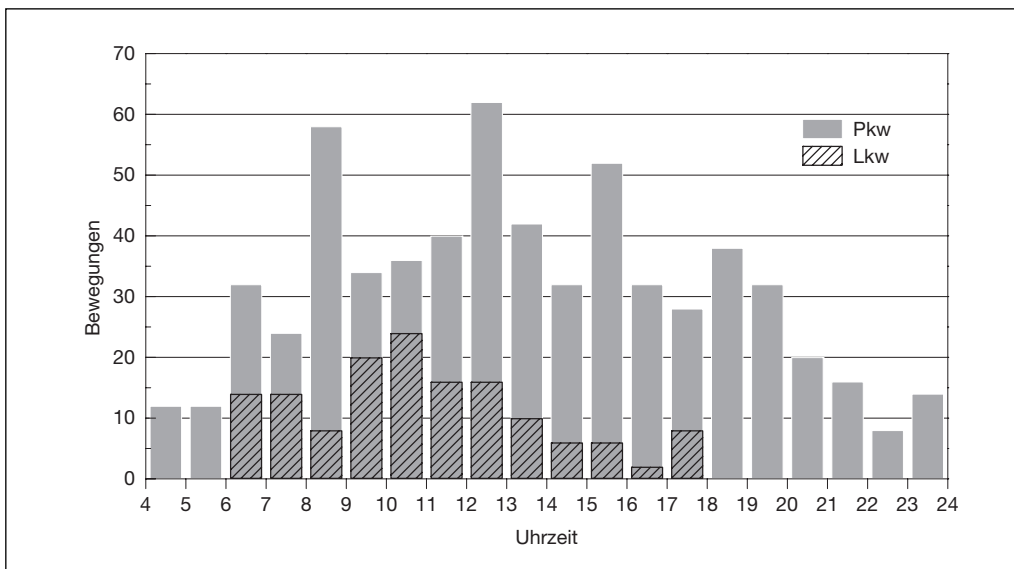


Fig. 3: Motion and occupancy pace near the filling station Fürholzen Ost, inquiry on Thursday, 02.12.2004

5.3 Parking Areas and Underground Car Parks near Housing Areas

The inquiries` results of the altogether nine examined housing areas are listed in Tab. 6.

Near three of the probe sites, beside carports of underground car parks, overground private carports belonging to the housing area and lying near the entrance to the underground car park could be listed. In the course of these housing areas` inquiries, the vehicle motions were determined for the underground carports and the overground carports separately.

To sum up, the following inquiries` results of the examined housing areas can be seen:

- The frequencies of motions found near underground carports are fluctuating heavily, but don`t show any significant differences between housing areas in rural areas and such ones in municipal areas.
- During the daytime (6 a.m. – 22 p.m.) an average motion frequency at the underground car parks of 0.09 motions per carport and hour was found. The maximum frequency of motion amounted 0.13 motions per carport and hour during the daytime near one probe site. At night the average motion frequency amounted 0.01 motions per carport and hour. In the 4. edition of the parking area noise study the maximum frequency of motion had erroneously been set to be 0.15 motions per carport and hour what was too high; after an inspection and due to new inquiries it was corrected and found to be 0.09 motions per carport and hour.
- In the case of the housing areas` overground carports, during the daytime an average motion frequency of 0.22 motions per carport and hour was found. The maximum value amounted 0.38 motions per carport and hour near one probe site.
- Compared with the underground carports, the overground carports are used more frequently; it can be supposed that the overground carports by the residents are rated to be more attractiv and secure. It can be seen that the overground carports provided for the residents are also partly used by the delivery traffic (mail, parcel service, beverage service, taxicabs etc.).

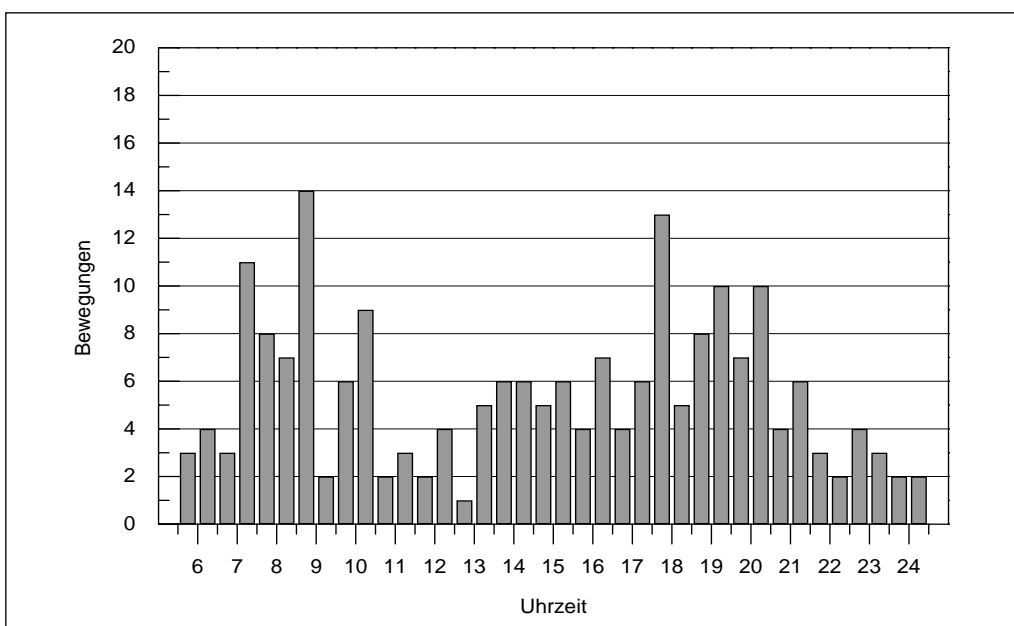


Fig. 4:
Motion paces of a housing area`s underground car park in München-Moosach, inquiry on Thursday, 17.06.2000

A motion pace typical for this type of parking area is shown in fig. 2 with the example of a housing area's underground car park in München-Moosach. The motion and occupancy paces of all examined housing areas' underground car parks are listed in [37].

5.4 Parking Areas near Discotheques

As can be seen in Tab. 7, altogether nine inquiries were performed near eight discotheques.

To sum up, the following inquiries' results are found near discotheques:

- Near five examined discotheques the inquired vehicle motions could be normalized to the respective net restaurant room ⁹⁾. During the, in a sound engineering way, most critical period "loudest hour at night", an average value of 2.82 of the frequency of motion (motions per 10 m² of net restaurant room and hour) was determined, two discotheques being visited relatively modestly (see Tab. 7). Near highly visited discotheques, during the period "loudest hour at night" frequencies of motion of 2.55 up to the maximum value of 5.61 were found. In that the "loudest hour at night" near the examined discotheques was found to be in partly different periods of time.

Tab. 7:
Inquiries' results of parking areas near discotheques

Inquiry probe site	Net restaurant room [m ²]	Number of carparks	Max. occupancy on inquiry date	Inquiry date			Remark	Total number of movements		Motions per 10 m ² net restaurant room and hour ⁶⁾				
				Date	Week-day	Time		Day 6a.m. - 22p.m.	Night 22p.m. - 6am.	Day 6a.m. - 22p.m.	Night 22p.m. - 6am.	Loudest hour at night		
											Time			
Discotheque in the district Günzburg, rural area	N. d. 10)	135 11)	105	23.05.86	Fr.	22.00 - 23.00	Highly visited, d. at the fringe of the village	-	203	-	10)	10)	22 - 23	
				24.05.86	Sa.	19.30 - 1.00	Highly visited, d. at the fringe of the village	331	347	10)	10)	10)	22 - 23	
D. at the fringe of the city of München	250	Approx. 200	47	25.06.99	Fr.	20.30 - 4.00	Rel. modestly visited	10	117	0.03	0.59	1.00	23 - 24	
D. in the district Unterallgäu, rural area	N. d. 10)	64 11)	22	02.07.99	Fr.	20.00 - 2.00	Visited subaveragely	14	28	10)	10)	10)	0 - 1	
D. in a small town in the district Aichach - Friedberg	530	550 11)	368	09.07.99	Fr.	20.00 - 1.30	Highly visited, d. outside the village	48	579	0.06	1.37	4.00	22 - 23	
D. in a small town in the district Weilheim - Schongau	376	Approx. 140	216	05.05.00	Fr.	20.00 - 4.00	Highly visited, d. at the fringe of the village	77	866	0.13	2.88	5.61	0 - 1	
D. in the district Günzburg, rural area	498	120 11)	86	12.05.00	Fr.	20.00 - 4.00	d. at the fringe of the village	102	505	0.13	1.27	2.55	0 - 1	
D. in the district Augsburg, rural area	N. d. 10)	65	42	20.05.00	Sa.	20.00 - 4.00	N. d.	58	238	10)	10)	10)	22 - 23	
D. in a small town in the district Aichach - Friedberg	480	70	29	27.05.00	Sa.	21.00 - 6.00	Rel. modestly visited	12	218	0.02	0.57	0.92	1 - 2	
								Average		0.07	1.34	2.82		

- no motions during the inquiry's period

- When the frequencies of motion are normalized, for a straight comparison with the statements of the 3rd edition of the parking area noise study [30], to the carports` number, near the nine examined discotheques during the period "loudest hour at night" an average value of 1.07 motions per carport and hour is found. The inquiries performed in 1986 showed a maximum value of 1.82 motions per carport and hour during the "loudest hour at night"; the inquiries performed in 1999 and 2000 found maximum values of the same magnitude of 1.48 resp. 1.52 motions per carport and hour near two probe sites during this period.

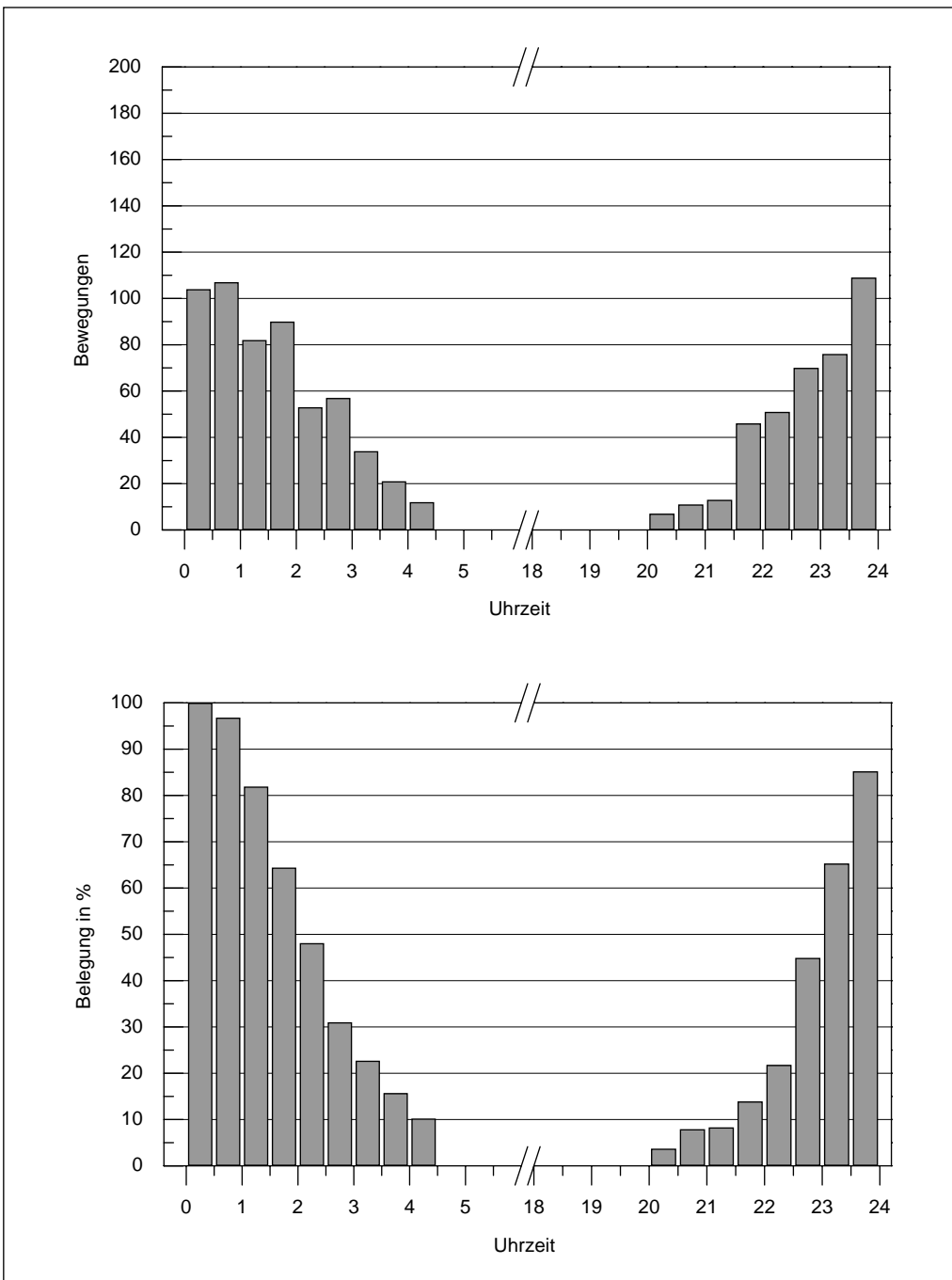


Fig. 5:
Motion and occupancy
paces near the parking
area of a small town`s
discotheque in the
district Weilheim-
Schongau, inquiry on
Friday/Saturday,
05./06.05.2000

- Compared with the inquiries of 1986, it is evident that the habits of the discotheque visitors obviously have changed: thus near the discotheque examined in 1986 already before 22 p.m. (period daytime: 6 a.m. – 22 p.m.) about 49% of all vehicle motions could be recorded, whereas near the discotheques examined in 1999 and 2000 this share is only about 14% in average. A vehicle motions` shift to the later hours of night is also seen in the respective period of the “loudest hour at night”: whereas in 1986 the “loudest hour at night” was in the period of 22 – 23 p.m., in the current inquiries mostly later periods (i.e. 0 –1 a.m.) were recorded for it.

The frequencies of motion shown in Tab. 7 refer to the total number of the vehicle motions ascribed to the discotheque operation. Near the examined discotheques, beside the carports offered by the discotheque manager, partly also further carports, e.g. longitudinal carports along the road or neighbouring carports, were used.

By means of exemplary additional investigations the vehicle motions near a probe site were determined, differentiated with respect to the carports offered by the discotheque manager and other carports . The results of these additional investigations are described in section 5.10.4.

In fig. 5 typical motion and occupancy paces for this type of parking area are shown in the example of a small town`s discotheque in the district Weilheim-Schongau. The motion and occupancy paces of all examined discotheques are listed in [37].

5.5 Parking Areas near Purchase Markets

As can be seen in Tab. 1 and Tab. 8, altogether 36 inquiries were performed near this type of parking area.

In older inquiries, the censuses were performed partly only during the business hours of the purchase markets. The mistake which is made, when in the rating levels` calculation the motions taking place outside business hours are not respected, is negligibly small (< 0,1 dB), yet.

The examined purchase markets were classified in the following subgroups:

- Purchase markets with a manifold offer of goods:
 - small consumer markets (net selling area up to 5000 m²)
 - large consumer markets resp. department stores (net selling area more than 5000 m²)
- Purchase markets with a specialized offer of goods:
 - discounter and beverage market
 - shops for electrical supply
 - markets specialized for construction supplies and furniture

For explanation: discounters or discounting markets, e.g. Aldi, Lidl or Plus, are low priced markets with a limited assortment ¹²⁾.

The censuses performed in the year 2004 resp. 2005 near consumer markets resp. markets specialized for construction supplies and furniture express the motion frequencies after the prolongation of the statutory shop closing times on 01.06.2003. The censuses in the years 1999 and 2000 took place before the elongation of the allowable opening time on Saturdays. Formerly it comprised the time period from 6 a.m. to 16 p.m., now it comprises the time period from 6 a.m. to 20 p.m.. Near two small consumer markets, where censuses had taken place already in 1999 resp. 2000, the censuses were performed again for a straight comparison.

Examinations of Vehicle Motions on Parking Areas

Tab. 8 part 1:
Inquiries` results of parking areas near purchase markets

Inquiry probe site	Net selling area [m ²]	Number of carports	Number of approaches	Max. occupancy on inquiry date	Inquiry date			Remark	Total number of movements		Motions per 10 m ² net selling area and hour ⁶⁾		
					Date	Week-day	Time		Day 6a.m. - 22p.m.	Night 22p.m. - 6am.	Day 6a.m. - 22p.m.	Night 22p.m. - 6am.	Loudest hour at night
Small consumer market (net selling area up to 5000 m²)													
Supermarket in München	800	74	3 a. (=l.)	38	12.06.99	Sa.	7.30 - 16.00		959	-	0.75	-	-
Supermarket in the district of München, rural area	750	44	3 a. (=l.)	41	30.10.99	Sa.	8.00 - 16.00	Village fringe	892	-	0.74	-	-
Consumer market in München	4900	300	1 a. + 1 l.	235	11.11.87	Wed.	8.00 - 19.00		4524	-	0.58	-	-
Consumer market in a small town in the district Deggendorf	1132	58	1 a. (=l.)	62	24.11.87	Tu.	7.30 - 18.30		1449	-	0.80	-	-
Consumer market in a small town in the district Augsburg	2470	185	1 a. + 2 l.	128	19.06.99	Sa.	8.00 - 16.15		2692	-	0.68	-	-
Consumer market in a small town in the district Augsburg	2552	179	1 a. (=l.)	152	09.10.99	Sa.	8.00 - 16.00		2603	-	0.64	-	-
Consumer market in a small town in the district Freising	3000	182	2 a. (=l.)	176	06.11.99	Sa.	7.30-16.00	Village fringe	5062	-	1.05	-	-
		181		110	18.12.04	Sa.	7.30-20.30		3883		0.81		
Consumer market in a market-town in the district Unterallgäu	2000	223	2 a. (=l.) + 1 l.	111	08.04.00	Sa.	7.30-16.00	Village fringe	2673	-	0.84	-	-
		220		82	13.11.04	Sa.	7.15-20.00		3278		1.02		
Consumer market in München	700	30	1 a. + 1 l.	35	18.12.04	Sa.	7.45 - 20.00		1913	-	(1.70)		
									<i>Average</i>		<i>0.79</i>	-	-

Self-service department stores (net selling area more than 5000 m²)

Department store in a small town in the district Rottal-Inn	7000	537	2 a. (=l.)	614	19.07.86	Sa.	10.30 - 19.00		4716	-	0.42	-	-
Department store in München	18000	978	1 a. (=l.)	408	11.11.87	Wed.	8.30 - 19.00		6820	-	0.24	-	-
Department store in Rosenheim	7060	429	1 a. (=l.)	299	26.06.99	Sa.	7.30 - 16.15		5794	-	0.51	-	-
Department store in a small town in the district Weilheim-Schongau	6000	565 U. c. p.: 454 Overgr.: 111	1 a. (=l.) +1 a. +1 l.	274 U. c. p.: 156 Overgr.: 118	16.10.99	Sa.	6.45 - 16.15		6141	-	0.64	-	-
Department store in Rosenheim	7000	350	1 a. (=l.)	371	04.12.04	Sa.	7.30 - 20.00		10751		(0.96)		
Departments store in a small town in the district Augsburg	6726	800	2 a. (=l.)	271	11.12.04	Sa.	7.45 - 20.00		5983		0.56		
									<i>Average</i>		<i>0.47</i>	-	-

- no motions during the inquiry's period;

in () value is disregarded (above-average traffic in the pre-Christmas period)

Examinations of Vehicle Motions on Parking Areas

Tab. 8 part 2:
Inquiries` results of parking areas near purchase markets

Inquiry probe site	Net selling area [m ²]	Number of carports	Number of approaches	Max. occupancy on inquiry date	Inquiry date			Remark	Total number of movements		Motions per 10 m ² net selling area and hour ⁶⁾		
					Date	Week-day	Time		Day 6a.m. - 22p.m.	Night 22p.m. - 6a.m.	Day 6a.m. - 22p.m.	Night 22p.m. - 6a.m.	Loudest hour at night
Discounter and beverage market													
Discounter in München	850	82	1 a. (=l.)	68	12.11.87	Thu.	8.30 - 19.00		2228	-	1.64	-	-
Discounter in München day with special offers	776	93	2 a. (=l.)	96	03.07.99	Sa.	7.45 - 14.15		1633	-	1.32	-	-
		92	2 a. (=l.)	92	08.11.04	Mo.	8.00 - 19.30	Aktionstag	3296	-	2.24		
Beverage market in the district Rosenheim, rural area	200	12	2 a. (=l.)	18	10.07.99	Sa.	7.45 - 13.45		369	-	1.15	-	-
Discounter in a small town in the district Augsburg	660	74	1 a. (=l.)	57	23.10.99	Sa.	8.00 - 13.00		908	-	0.86	-	-
Discounter in a small town in the district Augsburg	800	125	2 a. (=l.)	67	12.05.00	Fr.	8.30 - 19.00		2067	-	1.61	-	-
Discounter in a small town in the district Augsburg	630	50	1 a. (=l.)	20	29.11.04	Mo.	7.30 - 20.00	Aktionstag	847	-	0.84		
Discounter in a small town in the district Aichach-Friedberg	750	108	1 a. (=l.)	108	08.11.04	Mo.	8.00 - 19.00	Aktionstag	2587	-	2.16		
Discounter in a small town in the district Augsburg	700	120	2 a. (=l.)	34	06.12.04	Mo.	7.30 - 20.00	Aktionstag	1874	-	1.67		
Discounter in a small town in the district Augsburg	900	120	2 a. (=l.)	39	09.12.04	Thu.	7.30 - 20.00	Aktionstag	1470	-	0.72		
Discounter in a small town in the district Passau	1000	51	1 a. (=l.)	44	22.11.04	Mo.	7.30 - 20.00	Aktionstag	1294	-	0.81		
									Average		1.37	-	-
Electrical supply shops													
Electrical supply shop in a small town in the district Weilheim-Schongau	1200	48	1 a. + 1 l.	55	16.10.99	Sa.	9.00 - 16.00	Village fringe	892	-	0.46	-	-
Electrical supply shop in München	1800	60 U. c. p.: 16 Overgr.: 44	2 a. (=l.)	71 U. c. p.: 18 Overgr.: 53	06.11.99	Sa.	8.30 - 16.00	Village fringe	1779	-	0.62	-	-
									Average		0.54	-	-
Specialized markets for construction supplies and furniture													
Specialized market for construction supplies in a small town - in the district Weilheim-Schongau	6500	207	5 a. (=l.)	162	17.07.99	Sa.	7.45 - 16.15		2379	-	0.23	-	-
				207	22.01.05	Sa.	8.00 - 18.00		3647	-	0.35		
- in the district Augsburg	4800	243	1 a. + 1 l.	243	15.04.00	Sa.	7.30 - 16.00	Village fringe	3047	-	0.40	-	-
Design and decoration center in München	3400	100	3 a. (=l.)	92	09.10.99	Sa.	9.00 - 16.00	Village fringe	1428	-	0.26	-	-
Specialised market for furniture in Rosenheim	7500	150	1 a. (=l.)	96	23.10.99	Sa.	9.00 - 16.00		1605	-	0.13	-	-
Furniture market in a small town in the district Fürstentfeldbruck	1650	20	2 a. (=l.)	15	15.07.00	Sa.	9.00 - 16.00		141	-	0.05	-	-
									Average		0.24	-	-

- no motions during the inquiry's period

Near discounting markets in the year 2004 censuses were performed specifically during so called "Aktionstage". During these days which are characterized by offers promoted especially (preferably of the non-foodstuffs) increasingly high traffic volumes were watched by persons concerned. Depending on the offer's attractiveness (e.g. computer, children wear or the like) the censuses show more or less intense increases of the traffic volume compared with other weekdays. As these offers in discounting markets are set as a rule twice a week (mostly on Monday and Thursday), these days cannot be classified as "rare events" in terms of the TA Lärm a priori. To what extent the high traffic volumes found in this inquiry are caused by especially attractive offers and how often such offers are placed, cannot be clarified finally within the framework of this inquiry. Anyway these censuses' results are not taken into account for the determination of the forecast method's reference values. Alike the censuses' results inquired on weekends in Advent, partly showing clearly higher values, are not taken into account when determining the reference values (cf. Tab. 8).

To sum up, the following inquiries' results can be found near the examined purchase markets:

- In the subgroup "small consumer market" the average value of the inquired frequencies of motion during the day (6 a.m. – 22 p.m.) is 0.79 motions per 10 m² net selling area and hour (without the census performed on 18.12.2004 in München). The motion frequencies' maximum value during the day is 1.70 motions per 10 m² net selling area and hour for this subgroup. The corresponding census on 18.12.2004 however took place on the last weekend in Advent near a centrally located consumer market in the centre of a part of town. When proposing the reference values, the value 1.70 therefore is not taken into account and the value of 1.05 motions per 10 m² net selling area and hour of the consumer market in the district Freising is taken as a basis.
- In the subgroups "department store" and "electrical supply shops" average frequencies of motion of 0.47 resp. 0.54 motions per 10 m² net selling area and hour during the day were found. The motion frequencies' maximum values during the day are 0.64 resp. 0.62 motions per 10 m² net selling area and hour for these subgroups. Due to the weekend in Advent, the census near the self-service department store in Rosenheim is not taken into account when proposing the reference values for the sound engineering forecast.
- The subgroup "discounter and beverage market" shows the highest average frequency of motion during the day of 1.37 motions per 10 m² net selling area and hour. The maximum motion frequency during the day is 2.24 motions per 10 m² net selling area and hour for this subgroup (on so-called "Aktionstage"). The maximum frequency of motion on normal weekdays is 1.64 motions per 10 m² net selling room and hour. The observed differences of the motion frequency between the discount markets are very large comparatively.
- The lowest average frequency of motion during the day was inquired for the subgroup "market specialized for construction supplies and furniture". It is 0.24 motions per 10 m² net selling area and hour. For this subgroup a maximum motion frequency during the day of 0.40 motions per 10 m² net selling area and hour was determined.

In fig. 6 typical motion and occupancy paces for this type of parking area are shown in the example of a department store in Rosenheim. The motion and occupancy paces of all examined purchase markets are listed in [37].

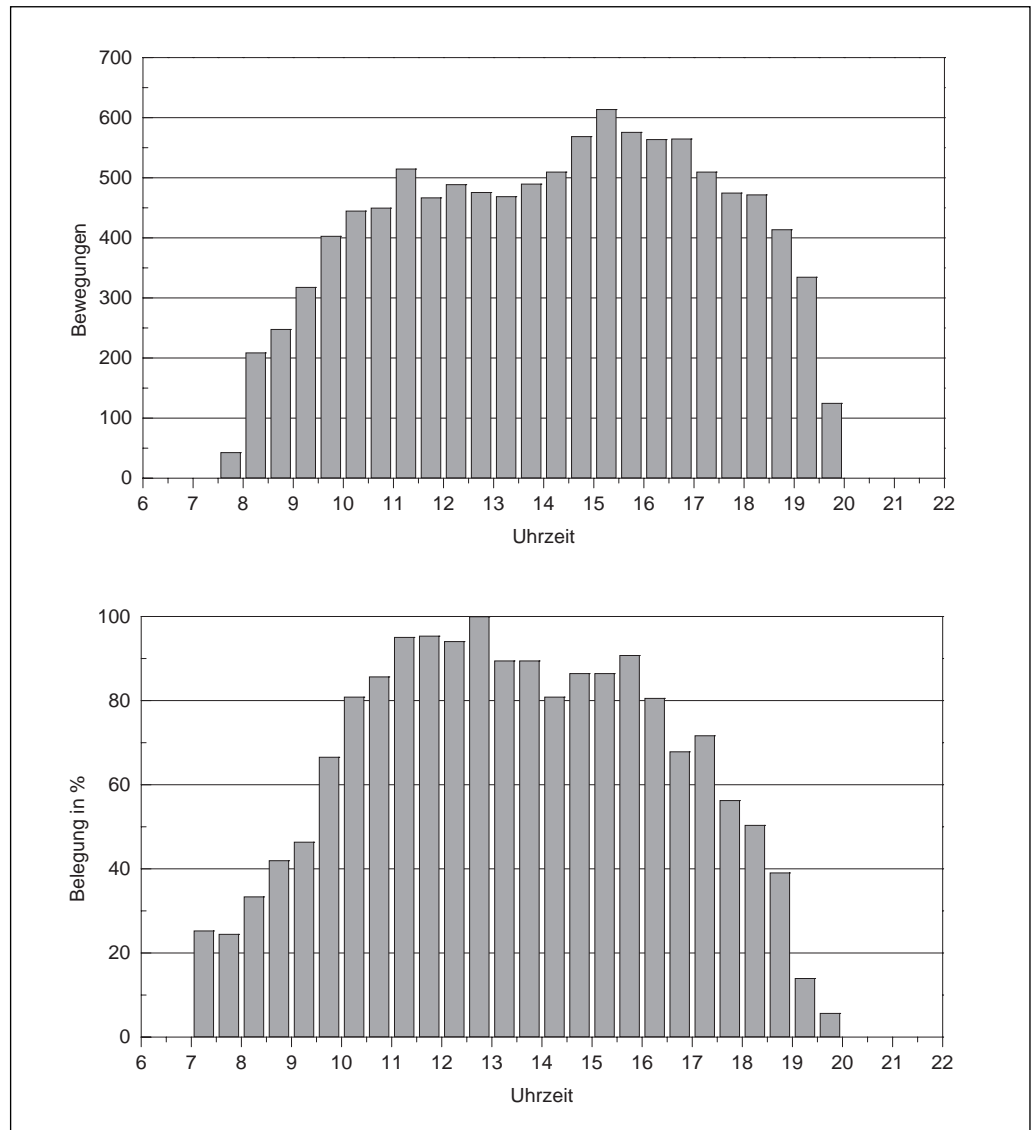


Fig. 6:
Motion and occupancy
paces of the parking area
near a department store
in Rosenheim, inquiry on
Saturday, 04.12.2004

5.6 Parking Aeras near Restaurants

As can be seen in Tab. 9, altogether 13 inquiries were performed near this type of parking area.

The examined parking areas near restaurants were classified in the following sub-groups:

- City restaurants,
- restaurants in the rural district,
- excursion restaurants,
- quick service restaurants (self-service restaurants), vehicle motions` inquiry differentiated in
 - restaurant visitors and
 - customers of the "Drive-In" service (purchase of foods and drinks, from car, at the drive-in counter).

In the restaurants the service by the staff is done at the tables, in the quick service restaurants the customers choose foods and drinks at the bars in front of the cash-desk and only afterwards approach the tables. In Tab. 9 the determined frequencies of motion are listed, normalized to the respective net restaurant room of the examined restaurants (motions per 10 m² net restaurant room and hour). The drive-in counters of the quick service restaurants are an exception: as a normalization to the net restaurant room doesn't seem to be efficient here, the frequencies of motion are given in „motions per hour“. The inquiries were performed during the empirically well visited days of the weekends.

To sum up, the following inquiries` results show near restaurants:

- The average values of the inquired motion frequencies during the day (6 a.m. – 22 p.m.) are 0.56, 0.75 and 0.73 motions per 10 m² net restaurant room and hour for the subgroups “city restaurants”, “restaurants in the rural district” and “excursion restaurants”, thus being of a comparable magnitude. The motion frequencies` maximum values during the day for these subgroups are 0.71, 1.16 and 1.04 motions per 10 m² net restaurant room and hour; the highest frequencies of motion during the day were found near restaurants in the rural district.
- During the period “loudest hour at night” for the subgroups “city restaurants”, „restaurants in the rural district” and “excursion restaurants” average motion frequencies of 0.66, 0.50 and 0.36 motions per 10 m² net restaurant room and hour are found. The maximum values for these subgroups during the period “loudest hour at night” are 0.83, 1.11 and 0.85 motions per 10 m² net restaurant room and hour. In particular for the subgroup “restaurants in the rural district” a clear difference between the maximum value (1.11) and the average value (0.50) can be noted down. As, according to the manager`s information, near the restaurant with the highest motion frequency as a rule on Fridays a visitation comparable to the inquiry date is prevailing, this seems to be no “runaway”.
- For the subgroup “quick service restaurants” (self-service restaurants) with 2.70 motions per 10 m² net restaurant room and hour a clearly higher average motion frequency during the day was determined compared to the other examined restaurants (vehicle motions by restaurant visitors). The found maximum frequency of motion during the day is 3.72 motions per 10 m² net restaurant room and hour for the quick service restaurant examined in München and is thus lying above the value determined near a small town`s quick service restaurant by about the factor 2. During the period “loudest hour at night” the motion frequency determined in München even by about the factor 5 is lying above the corresponding small town`s value.
- In the case of the restaurants with a “Drive-In” service, near the two examined quick service restaurants during the day (6 a.m. – 22 p.m.) motion frequencies of 15.5 resp. 37.6 motions per hour were found. During the period “loudest hour at night” 24 resp. 36 vehicle motions were counted. The maximum frequencies of motion during the day and during the period “loudest hour at night” were determined near the examined quick service restaurant in a small town; at night (22 p.m. – 6 a.m.) near the quick service restaurant in München higher frequencies of motion were found.
- Restaurants in the rural district in general are visited more at noon than in the evening.

The motion frequencies shown in Tab. 9 refer to the total number of the vehicle

Examinations of Vehicle Motions on Parking Areas

Tab. 9 part 1:
Inquiries` results of parking areas near restaurants

Inquiry probe site	Net restaurant room [m ²]	Number of carparks	Max. occupancy on inquiry date ¹³⁾	Inquiry date			Remark (number of seats)	Total number of movements		Motions per 10 m ² net restaurant room ⁶⁾				
				Date	Week-day	Time		Day 6a.m. - 22p.m.	Night 22p.m. - 6a.m.	Day 6a.m. - 22p.m.	Night 22p.m. - 6a.m.	Loudest hour at night		
													Time	
City restaurants														
Restaurant in München	144 14)	19	20	12.06.99	Sa.	11.00 - 24.00	Main traffic road (120 Seats)	92	12	0.40	0.10	0.49	23 - 24	
Restaurant in München	240 14)	22	44	13.06.99	Su.	11.00 - 24.00	City fringe area (200 Seats)	273	29	0.71	0.15	0.83	22 - 23	
								<i>Average</i>		<i>0.56</i>	<i>0.13</i>	<i>0.66</i>		
Restaurants in the rural area														
Restaurant in the district Augsburg	240 14)	120	49	19.06.99	Sa.	11.00 - 24.00	(200 Seats)	205	15	0.53	0.08	0.38	23 - 24	
Restaurant in the district München	96 14)	20	8	10.10.99	Su.	11.00 - 1.00	(80 Seats)	64	5	0.42	0.07	0.31	22 - 23	
Restaurant in the district Rosenheim	165	37	35	17.10.99	Su.	11.00 - 1.00	(145 Seats)	305	10	1.16	0.08	0.55	22 - 23	
Restaurant in the district München	240 14)	50	46	17.10.99	Su.	11.00 - 1.00	(200 Seats)	342	8	0.89	0.04	0.17	22 - 23 23 - 24	
Gaststätte im Lkr. Dachau	270	94	63	05.05.00	Fr.	11.00 - 24.00		315	70	0.73	0.32	1.11	0 - 1	
								<i>Average</i>		<i>0.75</i>	<i>0.12</i>	<i>0.50</i>		
Excursion restaurants														
Restaurant in the rural district Starnberg	165	30	45	03.07.99	Sa.	11.00 - 23.00	(180 Seats)	275	16	1.04	0.12	0.85	22 - 23	
Restaurant in the rural district Starnberg	250	70	56	07.11.99	Su.	11.00 - 1.00	(220 Seats)	331	13	0.83	0.07	0.28	22 - 23	
Restaurant in the rural district Landsberg a. Lech	250	35	53	14.05.00	Su.	6.00 - 24.00	20 Beds (208 seats)	280	11	0.70	0.06	0.24	23 - 24	
Restaurant in the rural district Bad Tölz	165	41	9	04.06.00	Su.	11.00 - 23.00	10 Beds (190 seats)	93	1	0.35	0.01	0.06	22 - 23	
								<i>Average</i>		<i>0.73</i>	<i>0.07</i>	<i>0.36</i>		
Quick service restaurants														
Q. in München	91	23	23	26.06.99	Sa.	11.00 - 24.00	Open at 10 a.m. (77 seats)	541	105	3.72	1.44	5.93	22 - 23	
Q.in a small town in the district Weilheim-Schongau	179	30	29	10.07.99	Sa.	11.00 - 23.00	Open only until 23 p.m.; village	478	20	1.67	0.14	1.11	22 - 23	
								<i>Average</i>		<i>2.70</i>	<i>0.79</i>	<i>3.52</i>		
- no motions during the inquiry's period														

Inquiry probe site	Inquiry date			Remark	Total number of movements		Motions per hour ⁶⁾				
	Date	Week-day	Time		Day 6am. - 22p.m.	Night 22p.m. - 6a.m.	Day 6am. - 22p.m.	Night 22p.m. - 6a.m.	Loudest hour at night	Time	
Quick service restaurant in München, drive-in-counter	26.06.99	Sa.	11.00 - 24.00	Open at 10 a.m.	248	44	15.5	5.5	24	23 - 24	
Quick service restaurant in a small town in the district Weilheim-Schongau, drive-in-counter	10.07.99	Sa.	11.00 - 23.00	Open only until 23 p.m. ; village fringe	602	36	37.6	4.5	36	22 - 23	
<i>Average drive-In</i>								26.6	5.0	30	

Tab. 9 part 2: Inquiries` results of drive-in counters of quick service restaurants ("Drive-In")

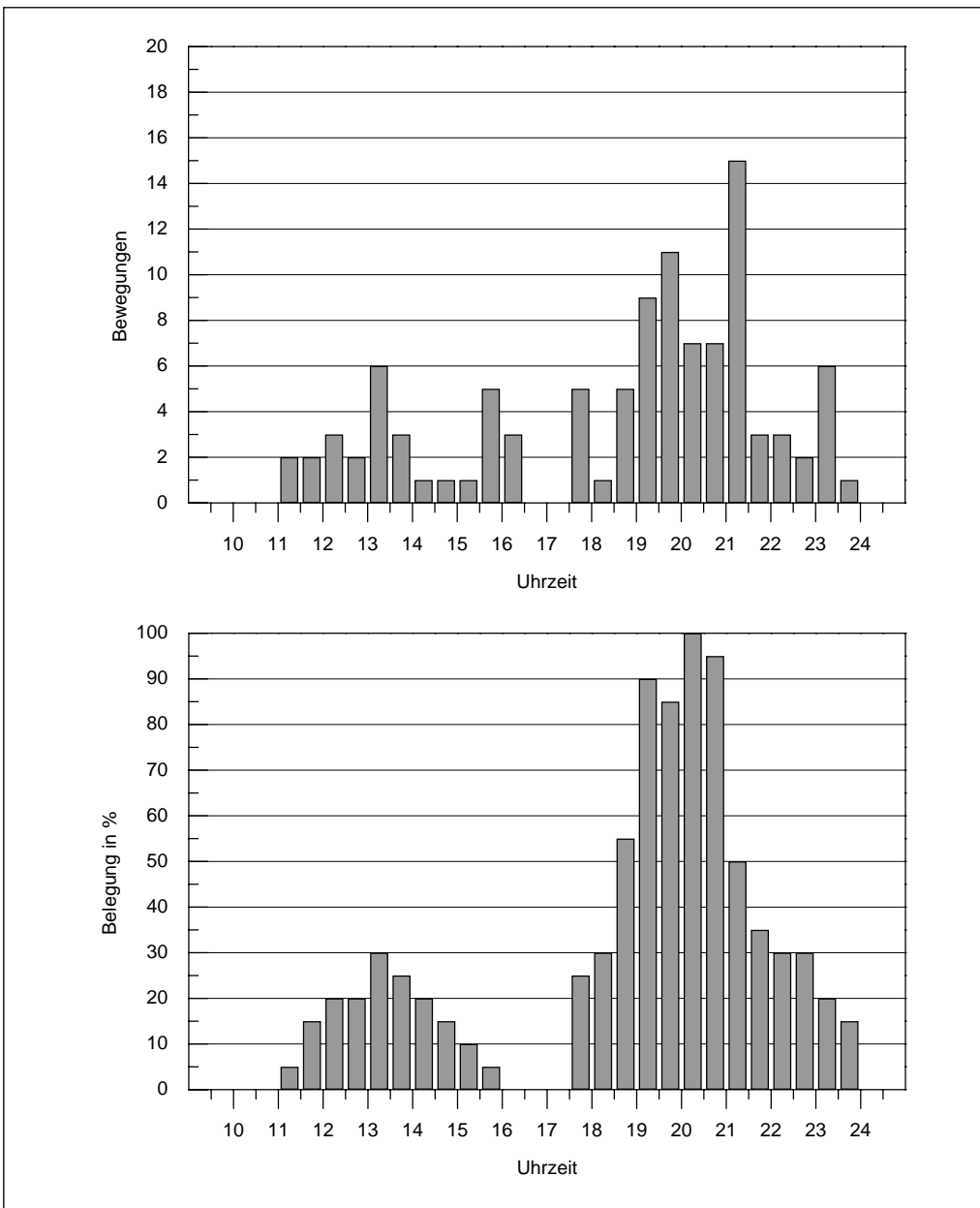


Fig. 7: Motion and occupancy pace of a restaurant in München, inquiry on Saturday, 12.06.1999

motions which can be attributed to the restaurant operation. Also the drive-in counter involves the sum of the approaching and leaving movements, which is twice as large as the number of the motorcars going through on the driving lane to the counter. Near the subgroups "city restaurants", "restaurants in the rural district" and "excursion restaurants" the restaurant visitors` parking procedures partly also could be seen on public carports (e.g. longitudinal carports along the road). By means of exemplary additional investigations the vehicle motions near a probe site were determined, differentiated in the carports offered by the restaurant manager and public carports. The results of these additional investigations are described in sect. 5.10.5.

Within the framework of the inquiries, as an additional information an average numerical coherence between the net restaurant room and the number of seats was calculated:

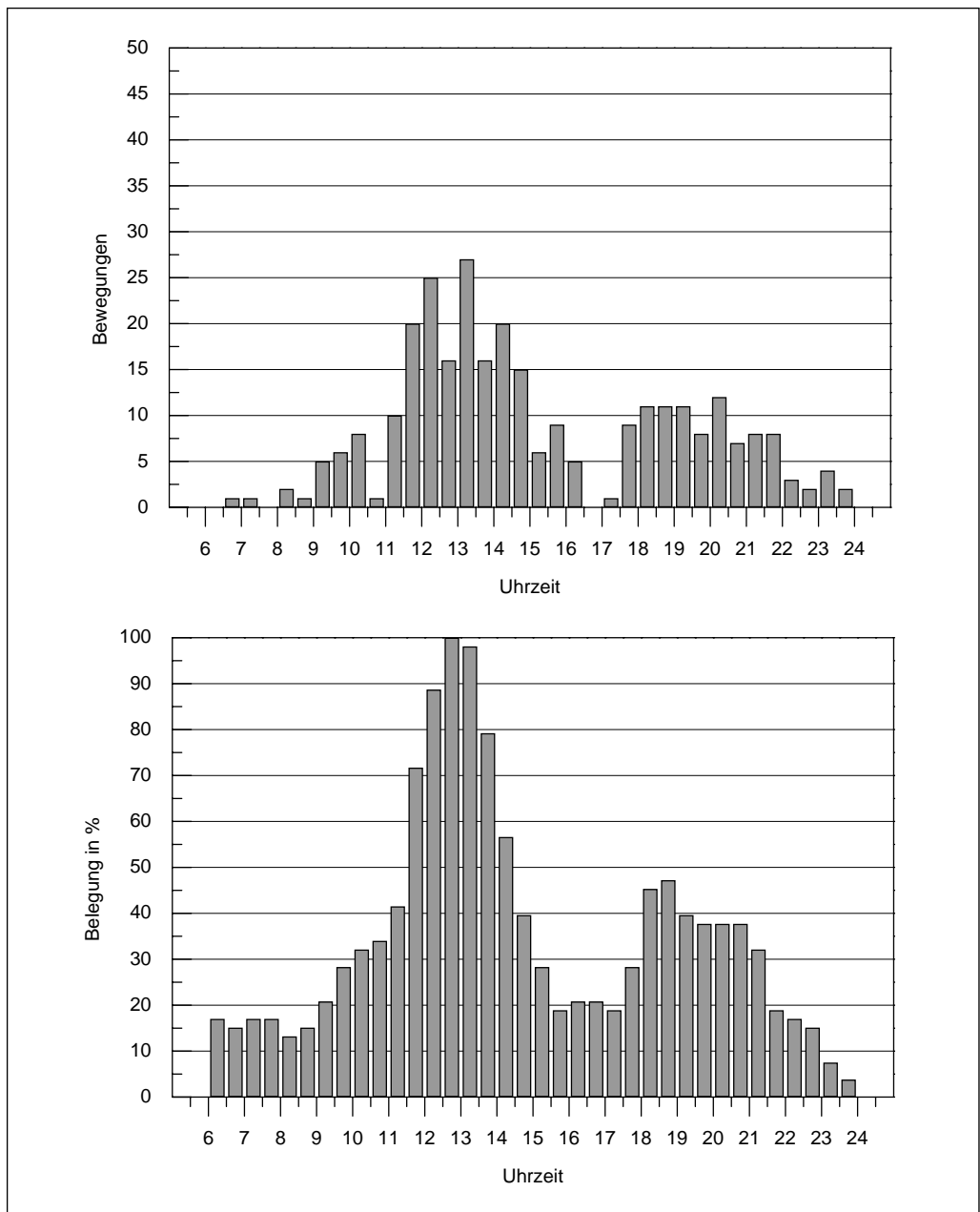


Fig. 8:
Motion and occupancy pace of the parking area near a restaurant in the rural district of Landsberg (public and private carports), inquiry on Sunday, 14.05.2000

to average one seat claims a net restaurant room of about 1.2 m². In individual cases only the number of seats of the examined restaurants could be inquired; in these cases the respective net restaurant room was numerically determined with the abovementioned factor.

In the Fig. 7 to Fig. 12 typical motion and occupancy paces for this type of parking area are shown. The motion and occupancy paces of all examined restaurants are listed in [37].

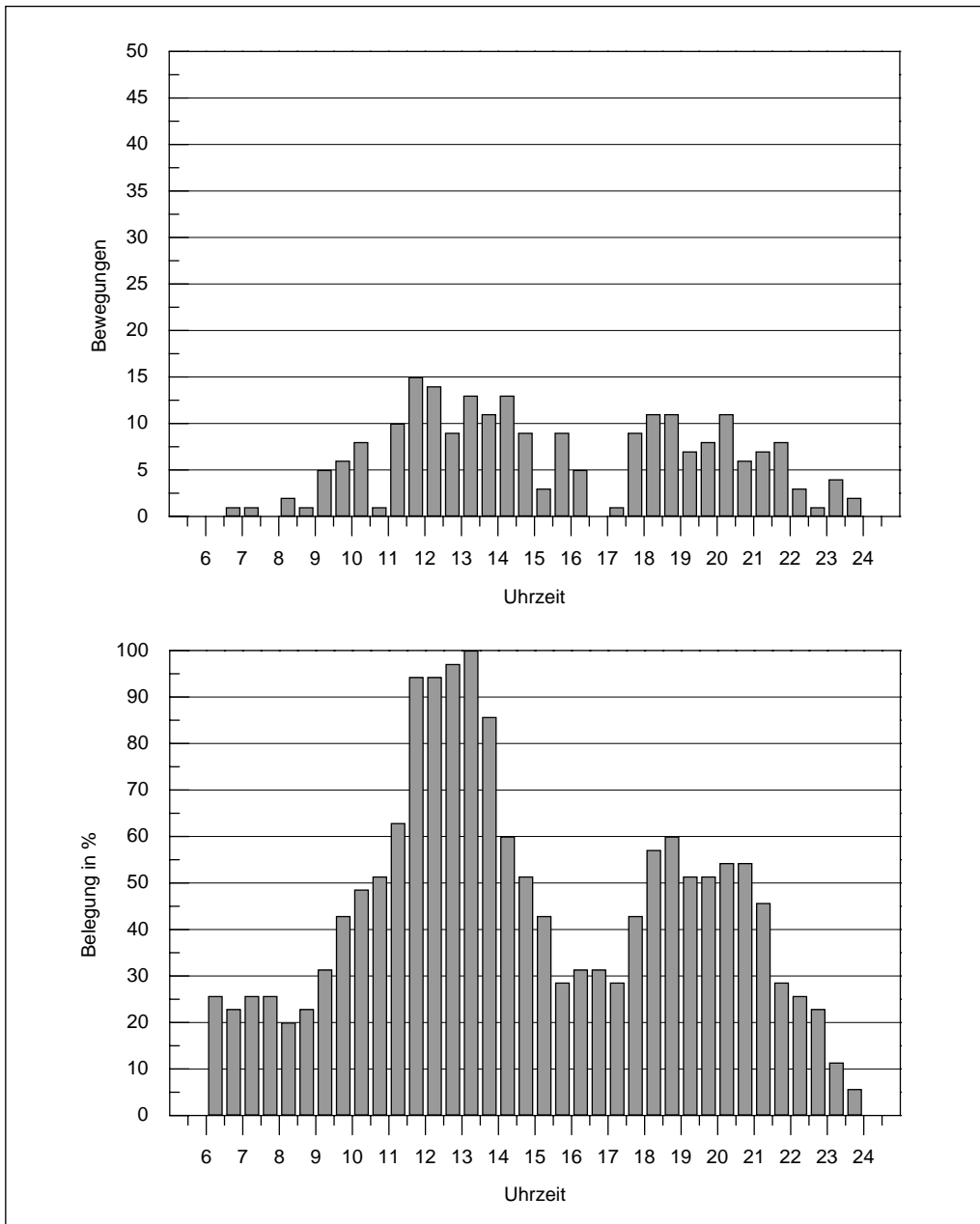


Fig. 9: Motion and occupancy pace of the parking area near a restaurant in the rural district of Landsberg (public and private carports), inquiry on Sunday, 14.05.2000

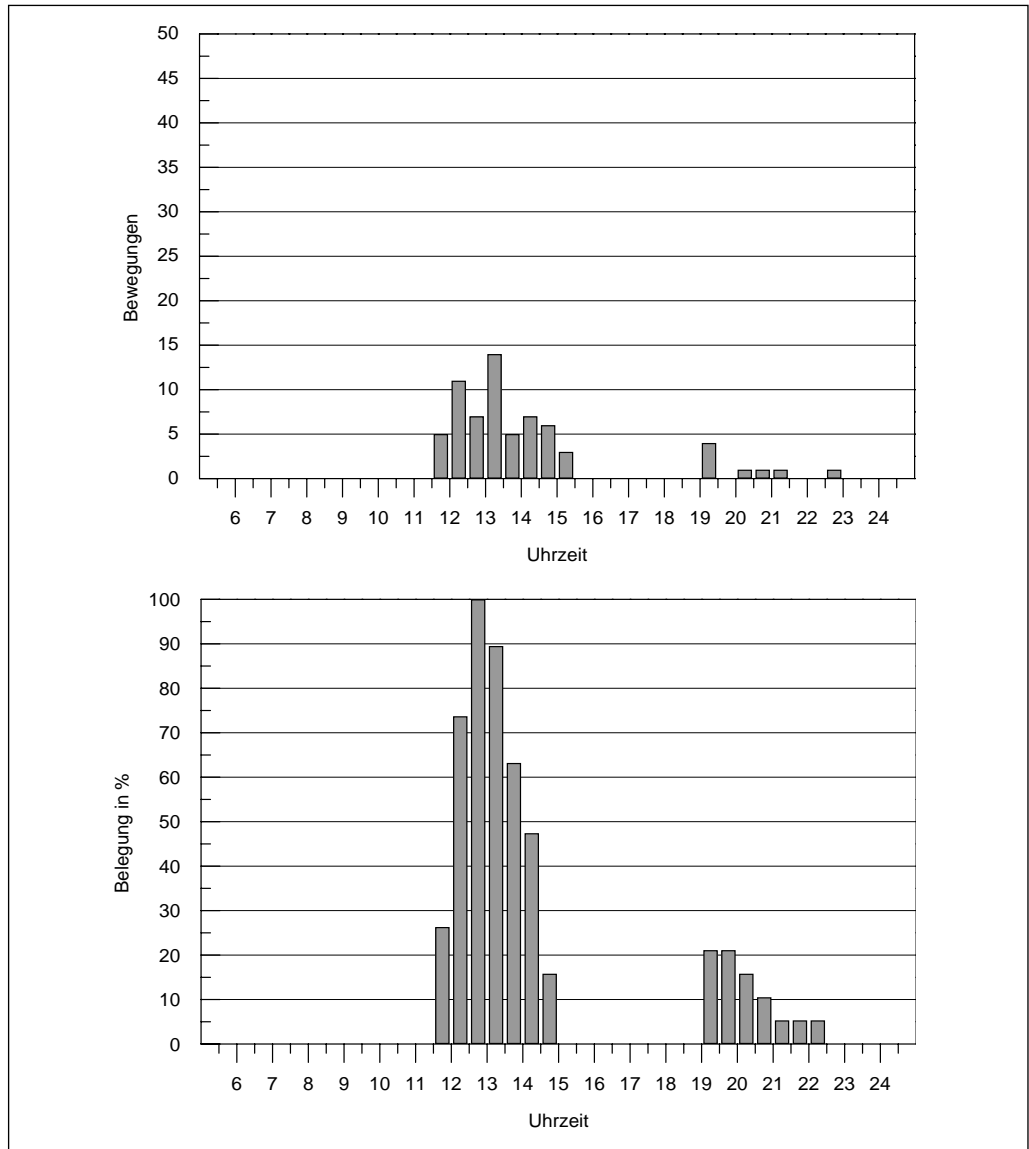


Fig. 10: Motion and occupancy pace of the parking area near a restaurant in the rural district of Landsberg (public carports), inquiry on Sunday, 14.05.2000

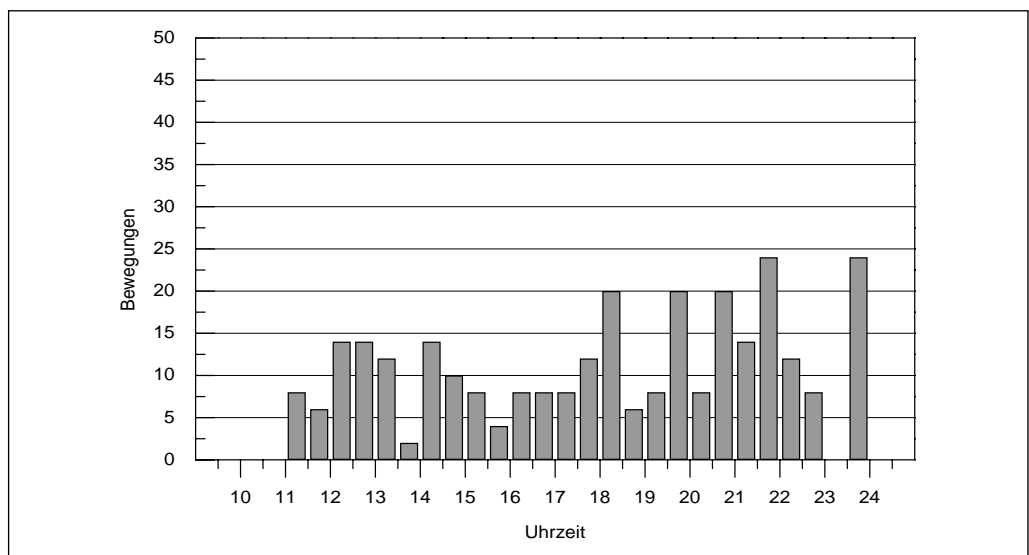


Fig. 11: Motion pace near a quick service restaurant in München (only drive-in counter "Drive-In") inquiry on Saturday, 26.06.1999

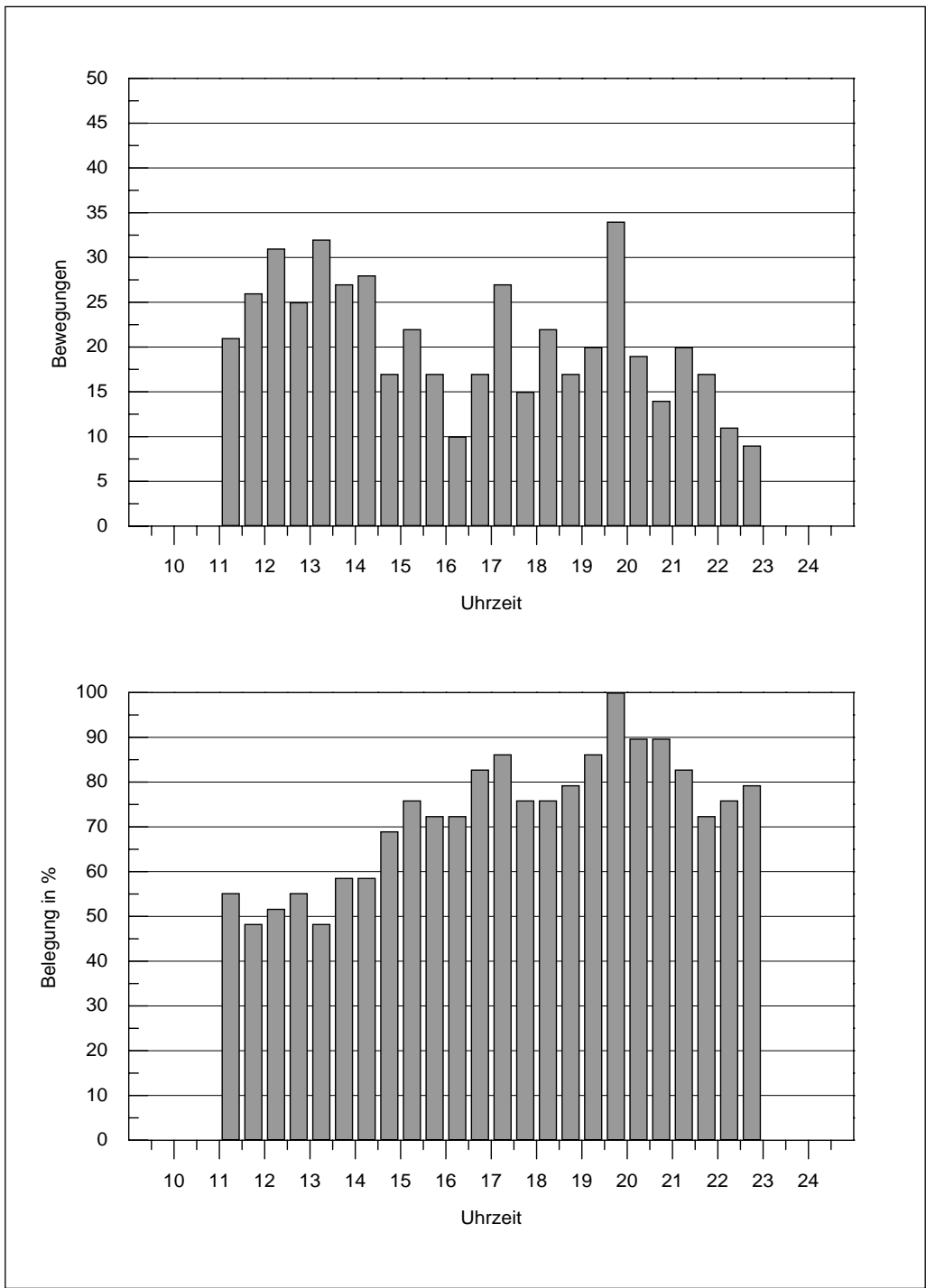


Fig. 12: Motion and occupancy pace of the parking area near a quick service restaurant in a small town in the district Weilheim-Schongau (without drive-in counter „Drive-In“), inquiry on Saturday, 10.07.1999

5.7 Parking Areas near Hotels

Inquiries were performed near altogether 7 hotels. The inquiries` results are listed in Tab. 10. The examined parking areas were classified in the following subgroups:

- Hotel small (number of beds < 100),
- hotel large (number of beds ≥ 100).

The frequencies of motion near hotels listed in Tab. 10 were normalized to the number of beds (motions per bed and hour). Taking into account the informations of the examined hotels` managers, there arises an average coherence between the number of the beds and that of the rooms of about 1.7 beds per room.

To sum up, the following inquiries` results near hotels are found:

- For “small hotels” an average value of the motion frequency of 0.07 motions per bed and hour was found during the day (6 a.m. – 22 p.m.); for “large hotels” this value is 0.05 motions per bed and hour.

Tab. 10:
Inquiries` results of parking areas near hotels

Inquiry probe site	Number of beds	Number of rooms	Number of carpports	Max. occupancy on inquiry date ¹³⁾	Inquiry date			Remark	Total number of movements		Motions per bed and hour ⁶⁾			
					Date	Week-day	Time		Day 6a.m. - 22p.m.	Night 22p.m. - 6a.m.	Day 6a.m. - 22p.m.	Night 22p.m. - 6a.m.	Loudest hour at night	Time
Small hotel (number of beds < 100)														
Hotel in a small town in the district Rosenheim ¹⁵⁾	65	36	50	16	27.06.99	Su.	6.00 - 24.00		30	0	0.03	0	0	-
Hotel in the rural district Starnberg ¹⁵⁾	61	35	17	17	03.07.99	Sa.	11.00 - 24.00		39	3	0.04	0.01	0.04	22 - 23
Hotel in a München suburb ¹⁶⁾	32	18	15	12	27.10.99	Wed.	6.00 - 24.00		48	0	0.10	0	0	-
Hotel in the rural district München ¹⁵⁾	90	54	45	42	02.11.99	Tu.	6.00 - 24.00		159	9	0.11	0.02	0.09	22 - 23
									<i>Average</i>		<i>0.07</i>	<i>0.01</i>	<i>0.03</i>	<i>22 - 23</i>
Large hotel (number of beds ≥ 100)														
Hotel in München ¹⁶⁾	163	92	27	20	18.07.99	Su.	6.00 - 24.00	Distance to trainstation < 0.5 km	43	6	0.02	0.01	0.02	22 - 23
Hotel in a small town in the district München ¹⁷⁾	100	75	55	48	28.10.99	Thu.	6.00 - 24.00		111	7	0.07	0.01	0.04	22 - 23
Hotel in München ¹⁸⁾	330	185	128	80	03.11.99	Wed.	6.00 - 24.00	Distance to trainstation about 9 km	290	28	0.06	0.01	0.06	22 - 23
									<i>Average</i>		<i>0.05</i>	<i>0.01</i>	<i>0.04</i>	<i>22 - 23</i>

- no motions during the inquiry's period

- The motion frequencies` maximum values during the day are 0.11 resp. 0.07 motions per bed and hour for "small" resp. for "large" hotels.
- During the period "loudest hour at night" motion frequencies` maximum values of 0.09 resp. 0.06 motions per bed and hour were determined for "small" resp. "large" hotels.
- As expected, for hotels in a large city the frequency of motion also depends on the distance to the trainstation. In the subgroup "hotels large", for a hotel situated nearby the trainstation a motion frequency lower by the factor 3 was detected per one period of time, compared with a hotel which is situated about 9 km away from the city centre. A similar tendency also might be expected for hotels near airports.

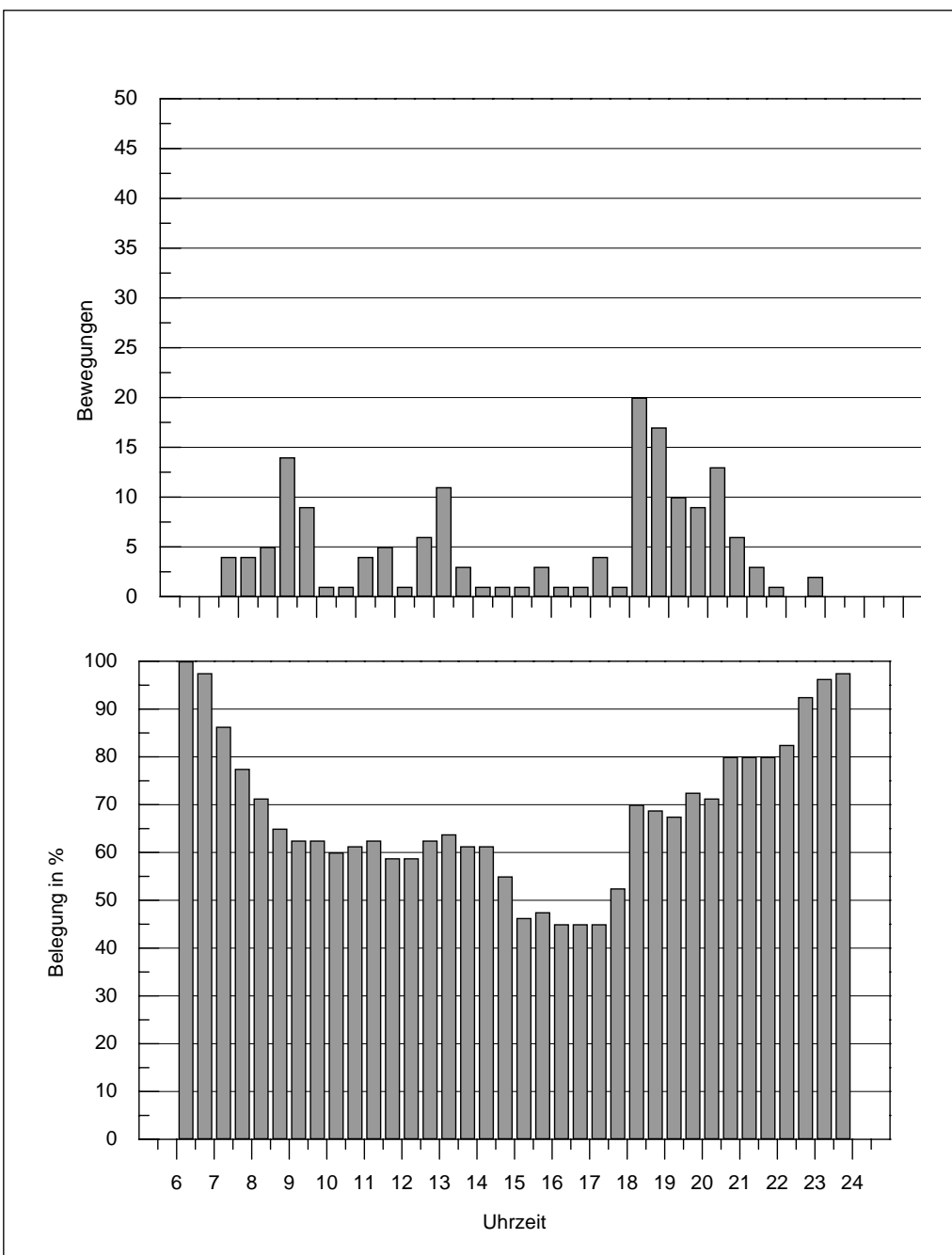


Fig. 13: Motion and occupancy pace of a hotel's parking area in München, inquiry on Wednesday, 03.11.1999

In fig. 13 typical motion and occupancy paces are shown for this type of parking areas in the example of a hotel in München. The motion and occupancy paces of all examined hotels are listed in [37].

5.8 Parking Areas near Pubs and Inns

In a “pub” or “inn” the restaurant operation has no secondary importance compared to the lodging operation. For the pub’s or inn’s parking area, the vehicle motions must be investigated separately for the zones of the restaurant and of the lodging operation.

In the context of this survey the meaning of “pub” or “inn” is a hotel with an associated restaurant with external effect, and external effect means that the restaurant is visited in substance by non-hotel-guests.

The inquiries` results near pubs and inns are listed in Tab. 11. Inquiries were performed near altogether five pubs and inns.

For pubs and inns the vehicle motions can not be normalized, like in the case of restaurants resp. hotels, to a reference value (net restaurant room or number of beds), as both the restaurant and the hotel operation similarly contribute to the number of vehicle motions and because it was not always possible on-site to assign the motions to the restaurant resp. to the hotel.

It is for this reason that in the following the, by way of calculation expected, motion frequencies are determined separately for the restaurant and the hotel and added up following. The computational result is compared with the actually ascertained motion frequencies, thus testing the method’s plausibility

The computations base on the maximum frequencies of motion per parking area type resp. subgroup, as described in the sect. 5.6 and sect. 5.7. With regard to the small number of probe sites, this basic approach was chosen for a result on a “safe” position.

Tab. 11: Inquiries` results of parking areas near pubs and inns

In Tab. 11 the computationally prognosticated vehicle motions are confronted with the ascertained values.

Inquiry probe site	Number of beds	Net rest. room [m²]	Number of carports	Max. occupancy on inquiry date ¹³⁾	Inquiry date			Remark (number of seats)	Classification of movements' number computation ¹⁹⁾		Total number of movements determined on-site (computational number in brackets ²⁰⁾)				
					Date	Week-day	Time		Hotel	Pub/inn	Day 6am.-22pm	Night 22p.m.-6a.m.	Loudest hour at night		
													Time	Time	
Pub/inn resp. hotel in the rural district Rosenheim	52	168 21)	37	25	20.06.99	Su.	11.00 - 24.00	(140 Seats)	Hotel small	Excursion restaurant	108 (371)	6 (24)	6 (19)	22 - 23	
Pub/inn resp. hotel in the rural district Starnberg	Weekday	61	165	30	37	24.06.99	Thu.	11.00 - 24.00	(180 Seats)	Hotel small	Excursion restaurant	252 (382)	18 (26)	10 (20)	22 - 23
	Weekend	61	165	30	45	03.07.99	Sa.	11.00 - 23.00	(180 Seats)	Hotel small	Excursion restaurant	314 (382)	19 (26)	16 (20)	22 - 23
Pub/inn resp. hotel in a small town in the district Rosenheim	65	96 21)	50	21	27.06.99	Su.	6.00 - 24.00	(80 Seats)	Hotel small	Rural area	173 (293)	3 (35)	3 (17)	22 - 23	
Pub/inn resp. hotel in the rural district Rosenheim	100	-	67	58	25.07.99	Su.	6.00 - 24.00	Ref. values partly missing	-	-	691 (-)	12 (-)	10 (-)	22 - 23	
Pub/inn resp. hotel in a small town in the district Weilheim-Schongau	100	99	56	26	16.11.99	Tu.	6.00 - 24.00	(80 Seats)	Hotel large	Rural area	162 (296)	0 (33)	0 (17)	22 - 23	
Average percentage of the determined movements, referred to the motions prognosticated for the parking area type pub or inn, incl. the parking area type hotel											58,2 %	35,2 %	35,8 %	22 - 23	

- no motions during the inquiry's period

To sum up, the following inquiries` results show near pubs and inns:

- The number of the prognosticated vehicle motions per probe site, which were calculated on the basis of average motion frequencies per parking area type, exceeds the number of the actually ascertained motions. For each period of time an average percentage of the ascertained motions of 35.2% to 58.2% was found with reference to the prognosticated motions. So the prognosticated values are lying to average by about 40 – 65 % above the ascertained motion frequencies, i.e. the basic approach of adding up the expected vehicle motions from restaurants and overnight stay operation leads to motion frequencies lying on a “safe” position.

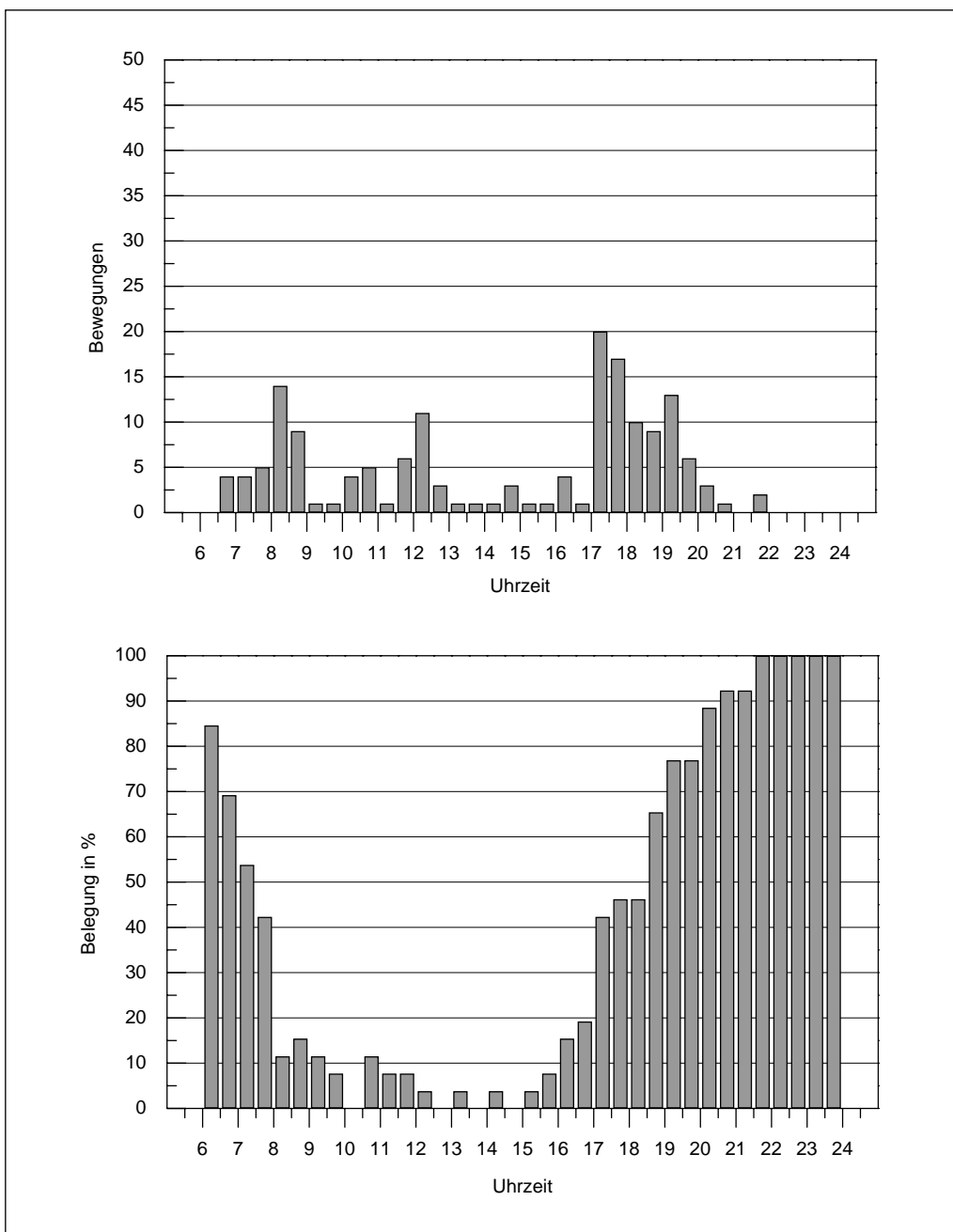


Fig. 14: Motion and occupancy pace of the parking area near a small town`s pub or inn in the district Weilheim-Schongau, inquiry on Tuesday, 16.11.1999

In fig. 14 typical motion and occupancy paces for this type of parking area are shown in the example of a small town's pub or inn in the district Weilheim-Schongau. The motion and occupancy paces of all examined pubs and inns are listed in [37].

5.9 Open-for-All Parking Areas and Multi-Storey Car Parks in City Centres

The inquiries' results near two open-for-all parking areas and two multi-storey car parks are listed in Tab. 12. The vehicle motions' investigation was made near the examined multi-storey car park in Rosenheim by means of a locally installed automatic counting device.

To sum up, the following inquiries' results show:

- During the day (6 a.m. – 22 p.m.) near the examined parking areas and multi-storey car parks an average motion frequency of 0.54 motions per carport and hour was found. In that during the investigation period the examined large parking area with a multi-storey car park near the trainstation of Erlangen (immediately at the city centre's edge) was fully occupied from time to time in the same way as the examined multi-storey car park in Rosenheim. The found motion frequencies of the parking area in Erlangen directly near the trainstation and at the same time at the city centre's edge indicate that this parking area to a considerable extent is used as a P + R area by commuters.
- The maximum motion frequency during the day near a public parking area in Weilheim was 0.94 motions per carport and hour. The reason for the high frequency of motion seems to be the parking taxation period which is prescribed for this chargeable parking area to be two hours in maximum as well as the parking area's

Tab. 12:
Inquiries' results of public parking areas and multistorey car parks in city centres

Inquiry probe site	Number of carports	Number of approaches	Max. occupancy on inquiry date	Inquiry date			Remark	Total number of movements		Motions per carport and hour ⁶⁾ related to max. occupancy				
				Date	Week-day	Time		Day 6a.m. - 22p.m.	Night 22p.m. - 6a.m.	Day 6a.m. - 22p.m.	Night 22p.m. - 6a.m.	Loudest hour at night		
												Time	Time	
Large parking area with multi-storey car park near Erlangen trainstation	1791	2 a. (=l.)	1791	25.11.87	Wed.	5.30 - 1.00	For part chargeable, for part free of charge ²²⁾ 887 carports in the multi-storey car park	7534	408	0.26	0.01	0.01	0.04	5 - 6 22 - 23
Multi-storey car park in Rosenheim (inquiries' data by automatic counting in the multi-storey car park) ²³⁾	445	1 a. (=l.)	445	From 14.12. to 24.12.98	Mo. - Sa.	6.00 - 22.45	Average	3054	4	0.43	0.00 ²⁴⁾	0.01	0.01	22 - 23
				22.12.98	Tu.		In maximum	3317	3	0.47	0.00 ²⁴⁾	0.01	0.01	22 - 23
Parking area Unterer Graben in Weilheim ²⁵⁾	80	1 a. (=l.)	51	23.06.99	Wed.	5.30 - 0.30		765	12	0.94	0.03	0.16		22 - 23
								Average ²⁶⁾		0.54	0.01	0.07	22 - 23	

advantageous position immediately at the city centre's edge near the pedestrian zone there.

- Near the examined multi-storey car park in Rosenheim during the day (6 a.m. – 22 p.m.) a maximum motion frequency of 0.47 motions per carport and hour was found. The examined multi-storey car park likewise is lying directly at the city centre's edge immediately near to manifold shopping facilities.

In fig. 15 exemplary motion and occupancy paces are shown in the example of the Rosenheim multi-storey car park. The motion and occupancy paces of all examined open-for-all parking areas and multi-storey car parks in city centres are listed in [37].

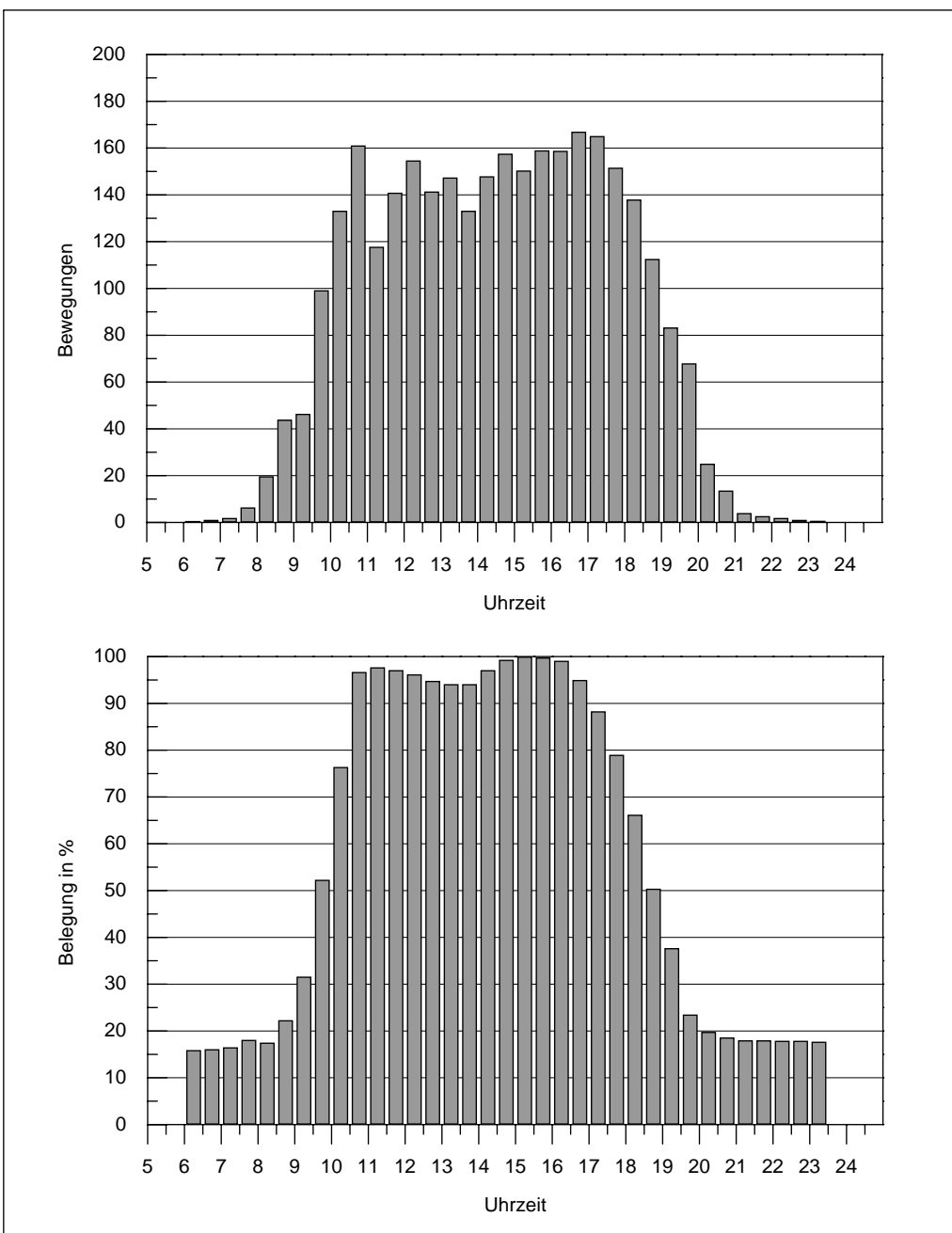


Fig. 15: Motion and occupancy paces near the Rosenheim multi-storey car park, on workdays (Mo. to Sa.), inquiry in December 1998

5.10 Additional Examinations for the Registration of Further Affecting Parameters

The following exemplary additional examinations were performed in view of quantifying further affecting parameters within the investigation themes' framework:

5.10.1 Motion Frequency's Dependence on Weekdays, Parking Area Type Pub or Inn

In order to determine the influence of different weekdays on the number of vehicle motions, inquiries were performed near a pub or inn on two different inquiry dates (on workdays/Weekend).

The investigations' detailed results and motion paces near this probe site are listed in Tab. 11 and in [37] ("pub or inn/hotel in the rural district of Starnberg", inquiries' dates: Thursday, 24.06.1999 and Saturday, 03.07.1999).

On the weekend near the examined pub or inn clearly higher motion frequencies could partly be recorded. The deviations of the motions inquired on the weekend, termed in Tab. 13, were determined compared with the motions on workdays.

Tab. 13:
Different vehicle motions on workdays and on the weekend near a pub or inn (example)

	Day 6a.m. - 22p.m.	Night 22p.m. - 6a.m.	Loudest hour at night 22p.m. - 23p.m.
Percentage deviation of motions determined on the weekend compared with those on workdays	+ 24.6 %	+ 5.6 %	+ 60.0 %

5.10.2 Motion Frequency's Dependence on the Carports' Distance to the Entrance of a DIY Store

In Tab. 8 are listed the inquiries' results, in [37] are listed the detailed inquiries' results and the motion paces of the entire moving procedures determined on the examined DIY store's parking area ("small town DIY store in the district Augsburg", inquiry's date: Saturday, 15.04.2000, period of time 7.30 a.m. - 16.00 p.m.). In ad-

Tab. 14:
Vehicle motions' dependence on the distance between carport and DIY store entrance (example)

Part of area	A	B	C	Total
Average distance to entrance and exit	About 30 m	About 45 m	About 65 m	-
Number of motions	829	1908	310	3047
Number of carports	53	143	47	243
Percentage of carports	21.8 %	58.9 %	19.3 %	100 %
Rate of net selling area [m ²] (conc. perc. of carports)	1046	2827	926	4800
Percentage of motions	27.2 %	62.6 %	10.2 %	100 %
Motions per 10 m ² net selling area and hour (time period day 6 a.m. - 22 p.m.)	0.50	0.42	0.21	0.40

dition at this parking area the vehicle motions were determined on three parts of the area with different distance to the entrance resp. exit of the DIY store. The inquiries' results are included in Tab. 14.

Based on the exemplary investigations, for a larger distance of the carports to the entrance resp. exit a lower motion frequency shows. For a safeguarded description of this dependence further investigations would be necessary.

5.10.3 Examinations of the Vehicle Motions near the Filling Station of a Purchase Market

In Tab. 8 and in [37] are listed the vehicle motions determined on the parking area of a "consumer market in a market-township in the district Unterallgäu" (inquiry's date: Saturday, 08.04.2000). In addition near this probe site the motions of a filling station associated to the consumer market were determined. In the following the vehicle motions on the parking area are confronted with the motions near the filling station. Referred to the total number of motions on the purchase market's parking area, near the filling station a vehicle motions' percentage of about 18% (Tab. 15) was determined. In noise engineering forecasts the motions near the filling station must be respected in addition. Forecast methods for that can be seen in [23].

In noise engineering forecasts for purchase markets' parking areas the motions near the filling station must be respected in addition.

Tab. 15: Segmentation of the vehicle motions between a purchase market and the associated filling station (example)

	Vehicle motions		
	Purchase market (223 Carports)	Filling station (2 petrol pumps)	Total
Number of motions	2673	574	3247
Percentage of motions	82.3 %	17.7 %	100 %

5.10.4 Examinations of the Vehicle Motions near a Discotheque, Differentiated with Respect to Special Discotheque Carports and Other Carports

Near the examined discotheque in a small town in the district Weilheim-Schongau (for an overview of the inquiries' results see Tab. 7) beside the carports offered by the

Tab. 16: Distribution of the vehicle motions at night (22 p.m. – 6 a.m.) near a discotheque with respect to in-house carports and public carports (example)

	Discotheque carports	Other carports	Total
Average distance to entrance resp. exit	About 40 m	About 150 m	-
Number of motions	593	273	866
Number of occupied carports	122	94	216
Percentage of occupied carports	56.5 %	43.5 %	100 %
Rate of net restaurant room [m ²] (conc. perc. of carports)	210	166	376
Percentage of motions	68.5 %	31.5 %	100 %
Motions per 10 m ² net restaurant room and hour (time period night 22 p.m. – 6 a.m.)	3.53	2.06	2.88

discotheque manager also other carports, e.g. longitudinal carports along the road or neighbouring carports, were used. Near this discotheque additional investigations of the vehicle motions at the special discotheque carports and at the other carports were performed (Tab. 16). The motion and occupancy paces found here are shown in [37].

As can be seen from the abovementioned inquiries` results, near the discotheque carports a higher frequency of motion could be found.

5.10.5 Examinations of the Vehicle Motions near a Restaurant, Differentiated with Respect to Special Restaurant Carports and Other Carports

Near the examined excursion restaurant in the rural district of Landsberg a. Lech (for an overview of the inquiries` results see Tab. 9) additional investigations of the vehicle motions at the carports offered by the restaurant manager and at public carports were performed. The motion and occupancy paces found here are shown in [37]. Tab. 17 shows the vehicle motions near a restaurant in the rural district, differentiated with respect to in-house and public carports.

In addition to the 35 restaurant carports, 19 public carports were occupied by restaurant visitors. Again, near the restaurant carports a higher frequency of motion was found.

Tab. 17:
Distribution of the vehicle motions near a rural district restaurant with respect to in-house carports and public carports (example)

	Restaurant carports	Public carports	Total
Average distance to entrance/exit	10 m	40 m	-
Number of motions	215	65	280
Number of carports	35	19	54
Percentage of carports	64.8 %	35.2 %	100 %
Rate of net restaurant room [m ²] (conc. perc. of carports)	162	88	250
Percentage of motions	76.8 %	23.2 %	100 %
Motions per 10 m ² net restaurant room and hour (time period day 6 a.m. – 22 p.m.)	0.83	0.46	0.70

6 Sound Level Measurements

6.1 Source Level Measurements of Parking Processes

For the source level measurements the procedure, used in the anterior editions, of adding up separate partial procedures to one parking process arithmetically, was not pursued any more. Both for motorcars, motorcycles and delivery vans and trucks complete parking processes were measured. Merely for busses up to now no measurements of complete parking processes do exist, the measured separate procedures were added up arithmetically.

The simulated parking processes are each composed of one approaching and one leaving procedure (with the appendant noises of door/boot shutting, compressed air noise of trucks etc.). For each vehicle the both moving procedures were averaged energetically. No unique tendency for the question, which of the both moving procedures is causing higher emissions, could be detected. To simplify, it can be assumed that one parking process causes emissions higher by 3 dB(A) than one parking procedure.

The source level measurements' results of parking procedures on parking areas at ground level can be found in Tab. 18 and Tab. 19 as well as in annex 6. In order to document the sound levels having appeared in maximum, in Tab. 19 for the examined vehicles the average maximum levels of the 7.5 m measuring point are listed. For each one of the examined vehicles an energy mean value for the maximum level per vehicle was averaged from several separate measurements. Taking into account the vehicle types' commonness and the frequency of the events' appearances, for the vehicle types "motorcycle" and "motorcar" normalized, energetically averaged maximum levels were calculated from this.

The maximum levels of motorcycles investigated in 1999 have not changed in comparison with recommendations in [30]. On the other hand the maximum levels measured for the actual motorcars exceed the so far data by about 1 dB(A). Within the scope of the simulation of parking movements near purchase markets, an average maximum level of the car tailgate's resp. boot's banging was ascertained lying over the maximum level of the car door's shutting noise by about 2 dB(A).

For busses and trucks clearly lower maximum levels were ascertained for part, compared to the so far data.

In Tab. 35 a recommendation, developed on basis of the abovementioned measurements' results and partly on bibliographical references, is given for the maximum levels that should be used in noise engineering calculations.

6.1.1 Motorcars, Motorcycles and Delivery Vans of up to 2.8 t of Permissible Total Weight

In the following the measurements' results for updating the sound emissions' character at parking processes are described and discussed.

Within the framework of the sound emissions' measurements of motorcars, motorcycles and delivery vans at simulated parking processes, beside typical parking processes on a P + R area (approaching and leaving movement incl. shunting and door shutting done twice), also parking processes near purchase markets and discotheques were simulated.

Sound Level Measurements

Tab. 18:
Sound power levels determined metrologically for 1 parking movement per hour - overview of the results of the source level measurements performed in 1999 by Möhler + Partner

Vehicle		Event	Determined sound power levels and surcharges for 1 parking motion per carport and hour in dB(A)			
Vehicle type, construction type, power, cylinder capacity	Year of construction		bold = average values per vehicle type			
			Number of measurements ³¹⁾	L _{WTeq}	L _{Weq} ³²⁾	K _I * ³³⁾
Motorcycle 27) In that 20.3% 2-cycle-vehicles 29)		Normal parking motion	30	70.6	65.7	4.9
Kawasaki ZR550 4cyl.-4cycle/25kW/550 ccm	1994	N. p. m.	8	67.5	62.7	4.8
Vespa P 125 X 1cyl.-2cycle/6kW/123 ccm	1991	N. p. m.	11	73.4	68.6	4.8
Honda Varadero 2cyl.-4cycle/69kW/996 ccm	1999	N. p. m.	11	71.9	66.9	5.0
Motorcar 27) 28) In that 13% diesel motorcars, 3,5% vans resp. lorries<3.5 t (in that 80% diesel vehicles)		N. p. m. with shopping trolley on asphalt	84	70.1	62.7	7.4
		with shopping trolley on pavement	28	73.0	65.4	7.6
			23	74.4	67.2	7.2
BMW 3er Otto/73kW/1596 ccm	1992	N. p. m. with shopping trolley on asphalt	12	69.7	62.1	7.6
		with shopping trolley on pavement	9	71.9	64.1	7.8
			9	73.6	67.0	6.6
Fiat Tipo Otto/57kW/1581 ccm	1990	N. p. m. with shopping trolley on pavement	15	69.5	62.2	7.3
			14	75.0	67.4	7.6
Ford Ka Otto/37kW/1299 ccm	1997	N. p. m.	9	69.0	61.4	7.6
Renault Clio Otto/40kW/1149 ccm	1997	N. p. m. with shopping trolley on asphalt	10	69.4	62.8	6.6
			11	72.7	65.3	7.4
Opel Kadett Diesel/42kW/1700 ccm	1990	N. p. m. with shopping trolley on asphalt	8	73.0	64.5	8.5
			8	74.0	66.4	7.6
Ford Mondeo Otto/66kW/1597 ccm	1990	N. p. m.	6	66.9	61.6	5.3
Volvo V 40 Otto/85kW/1731 ccm	1998	N. p. m.	8	69.3	61.5	7.8
Ford Transit Diesel/59kW/2496 ccm	1993	N. p. m. (without sliding door)	11	74.5	68.0	6.5
VW-Bus "Atlantic" (afterwards equipped with catalyst) Turbodiesel/ 51kW/1600 ccm	1990	N. p. m. (without sliding door) simulation for discotheque (incl. sliding door)	5	69.9	63.8	6.1
			8	71.3	64.6	6.7
Bus (total weight >2.8 t) 30)						
Kässbohrer Setra 5212 H		N. p. m.	12	77.1	72.8	4.3
Low corridor citybus with natural gas impulse		N. p. m.	11	73.3	69.9	3.4
Lorry 30) 34) (total weight > 2.8 t, measurement car center)		N. p. m.	10	81.2	77.0	4.2
MAN articulated lorry	300 kW	N. p. m.	2	81.9	77.9	4.0
MAN lorry with trailer	304 kW	N. p. m.	1	79.7	75.2	4.5
Mercedes articulated lorry	294 kW	N. p. m.	2	78.0	73.4	4.6
Renault articulated lorry	324 kW	N. p. m.	1	76.4	74.4	2.0
Mercedes articulated lorry	316 kW	N. p. m.	2	83.1	79.4	3.7
DAF petrol truck trailer	279 kW	N. p. m.	2	82.3	77.3	5.0

Vehicle			Event	Average maximum levels ³⁵⁾ in a distance of 7.5 m in dB(A) bold = det. maximum value in () not up to date any more	
Vehicle type	Year of construction	Construction type / Power / Cylinder capacity		Number of measurements	L _{AF} max, 7.5 m (mean value of measurements)
Motorcycle			Accelerated departure	16	73.1
Kawasaki ZR550	1994	4cyl./4cycle/25 kW/550 ccm	Accelerated departure	3	66.1
			Intensive accelerating ³⁷⁾	2	78.6
Vespa P 125 X	1991	1cyl./2cycle/6 kW/123 ccm	Accelerated departure ³⁸⁾	5	75.0
Honda Varadero	1999	2cyl./4cycle/69 kW/996 ccm	Accelerated departure	6	71.9
Motorcars (including vans)			Accelerated departure	-	-
			Door shutting	79	72.1
			Tailgate/ Sliding door ³⁶⁾	28	74.1
BMW 3er	1992	Otto/73 kW/1596 ccm	Accelerated departure	-	-
			Door shutting	12	72.3
			Tailgate ³⁶⁾	6	73.9
Fiat Tipo	1990	Otto/57 kW/1581 ccm	Accelerated departure	-	-
			Door shutting	12	74.0
			Tailgate ³⁶⁾	7	76.0
Ford Ka	1997	Otto/37 kW/1299 ccm	Door shutting	9	71.0
Renault Clio	1997	Otto/40 kW/1149 ccm	Door shutting	10	69.8
			Tailgate ³⁶⁾	4	72.8
Opel Kadett	1990	Diesel/42 kW/1700 ccm	Door shutting	8	73.8
			Tailgate ³⁶⁾	3	74.1
Ford Mondeo	1990	Otto/66 kW/1597 ccm	Door shutting	5	69.2
Volvo V 40	1998	Otto/85 kW/1731 ccm	Door shutting	8	70.3
Delivery vans					
Ford Transit	1993	Diesel/59 kW/2496 ccm	Accelerated departure	-	-
			Door shutting (without sliding door)	10	73.8
VW-Bus "Atlantic" afterwards equipped with catalyst	1990	Turbodiesel/70 PS/1600 ccm	Accelerated departure	-	-
			Door shutting (without sliding door)	5	71.3
			Door shutting (with sliding door)	8	72.6
Bus					
Kässbohrer Setra 5212 H (public service bus)			Driving past	3	73.9
			Accelerated departure	5	77.3
			Door closing	-	-
			Compressed air	-	-
			Starting	2	74.3
			Stand noise	3	68.6
Low corridor citybus with nat. gas imp.			Accelerated departure	4	74.2
			Stand noise	3	65.3
Lorry (car center)					
Measurement 1999			Driving past	11	80.1
			Accelerated departure	7	(80.5)
			Door closing	6	(75.2)
			Compressed air	3	(84.2)
			Starting	3	(78.0)
			Stand noise	10	70.1
			Cooling unit	5	71.7
			Clattering of empty trailer	1	87.0
Measurement 2005			Accelerated departure	12	78.6
			Door closing	13	72.7
			Compressed air	8	78.2
			Starting	7	74.7

Tab. 19:
Average maximum levels
in a distance of 7.5 m in
dB(A) – overview of the
results of the sound
emission measurements
performed in 1999

For the parking movements` simulation near a purchase market, in addition a shopping trolley was pushed and the car tailgate resp. boot were opened and closed. Standard shopping trolleys are generating a clacking noise when beeing pushed particularly on paved driving lanes. Purchase markets and the associated parking areas are scheduled not rarely in close vicinity to the customers. On the one hand, part of the traffic can thus be processed in an environment-friendly way on foot or with the bike, on the other hand the parking areas are thus lying quite near to house-buildings needing protection, so that it would be obvious in terms of a sound source`s protection to develop low-noise shopping trolleys. When using these shopping trolleys e.g. of the producer Wanzl Metallwarenfabrik GmbH, Leipzig, or a type comparable in an acoustical way, for the sound emission of parking areas with paved driving lanes near purchase markets a value lower by 2 dB can be put [25] (cf. Tab. 31 and Tab. 34).

During the parking movements` simulation on a discotheque`s carport in addition conversations and music entertainments from the car radio were recorded.

The vehicles chosen for the simulation show a typical cross section of the actual vehicle fleet; the vehicles` year of construction was varying from 1990 to 1999. The detailed vehicle parameters are listed in the source level measurements` result tables (Tab. 18 and Tab. 19).

For illustrating the measuring conditions, in fig. 16 a location outline of the noise level measurements of the simulated parking processes with details of the measuring points` position is shown. The measurements` results of the measuring point 1 (7.5 m measuring point) are serving for the marking of the sound levels appearing in maximum, whereas the measurements` results of the measuring point 2 (19 m measuring point) were taken as a base for the determination of the respective sound power levels (computation back to point acoustic source).

The arrival and departure of the vehicles was made on asphalt road surfaces, while the carport`s surface consisted of so called great stones with lawn joints. The joints showed a width of 2 to 3 cm and were continuously filled with humus.

In fig. 17 and 18 level-to-time diagrams of motorcars with Otto (petrol) and diesel

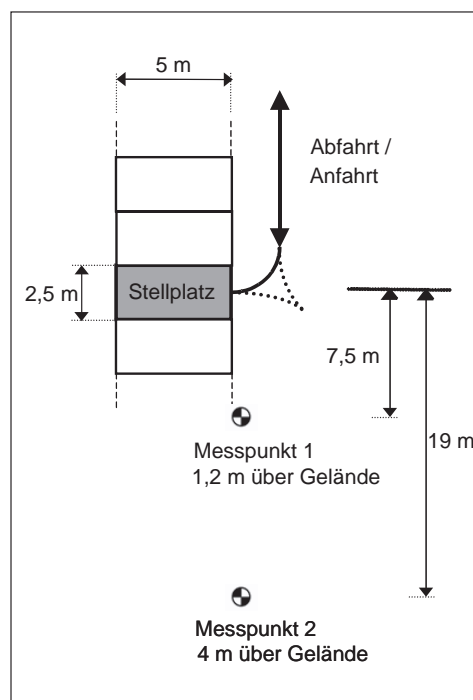


Fig. 16: Location outline of the sound level measurements of simulated parking processes

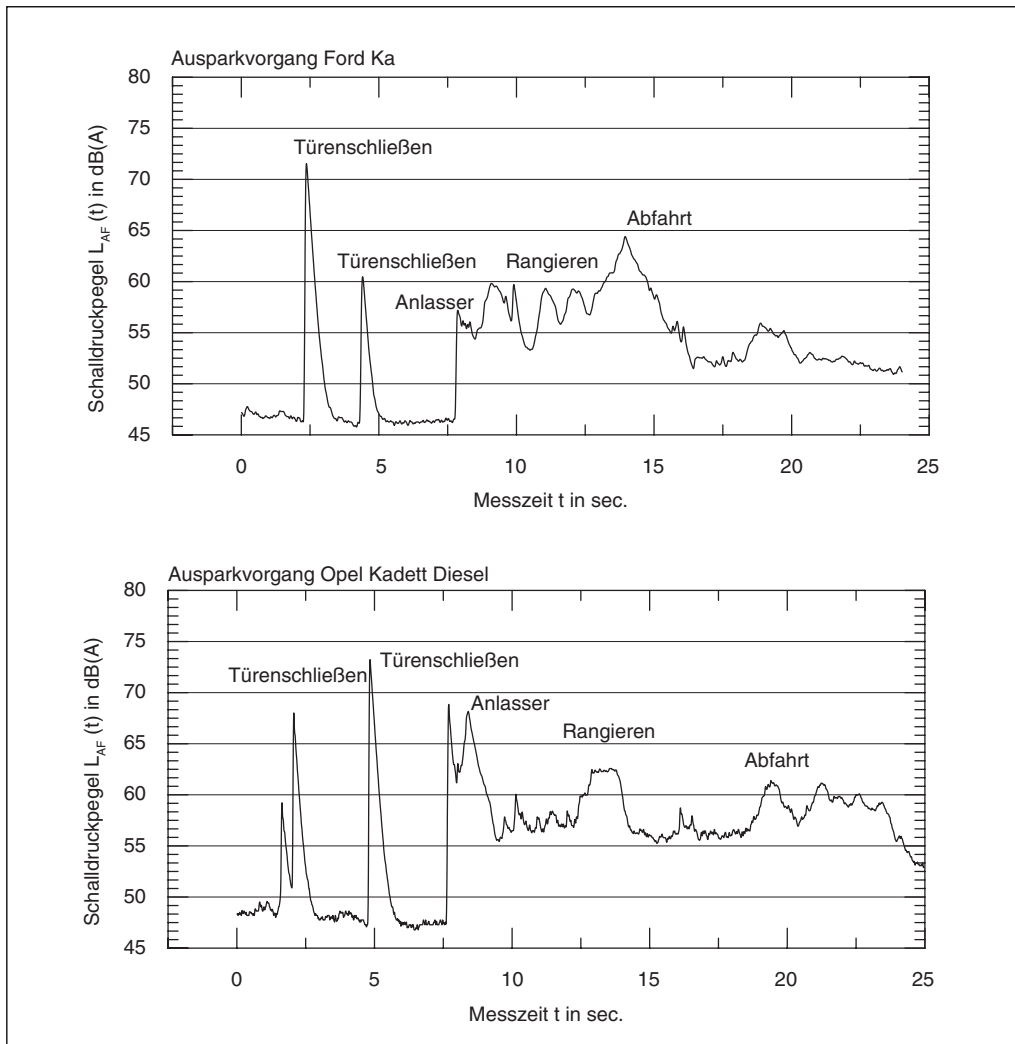


Fig. 17:
Exemplary level-to-time
diagrams of motorcars
with Otto (petrol) and
diesel engine when leav-
ing the carport (measur-
ing point 7.5 m)

engine as well as of a scooter and a motorcycle are shown when leaving the carport; in them the separate partial processes like door shutting, starting the engine, shunting, departure etc. can be recognized.

The overview of the sound power levels determined metrologically of one parking movement per hour, including the surcharges according to the stroke maximal level procedure for the examined vehicle types and vehicle species, can be taken from Tab. 18.

The representation of the measurements' results is made in Tab. 18 based on the respective average sound power level ($L_{W\text{eq}}$) of one parking movement per hour for the examined vehicles. To the further illustration of the measuring results, in addition the respective average sound power level of one parking movement per hour is given, respecting the stroke maximal level procedure ($L_{W\text{Teq}}$), although the surcharge to the stroke maximal level procedure strictly speaking is allowed only for sound immissions.

For each one of the examined vehicles one energy mean value for one parking movement per vehicle was formed from several individual measurements. Based on these measurements' results per vehicle, respecting the vehicle types' commonness (details to that in Tab. 18), in accordance with the registration statistics of the "Kraftfahrt-Bundesamt" (date 01.01.2000) the sound power levels of one parking move-

ment per hour for the vehicle types “motorcycle” and “motorcar” were calculated in the form of normalized energy mean values. During the parking movements a “normal” driving behaviour was simulated in order to record the case expected most frequently. Because the sound emissions, however, are depending on the driving behaviour, too (e.g. racy quality of driving), it was abstained from the information about the mathematical confidence ranges of the measurements` results.

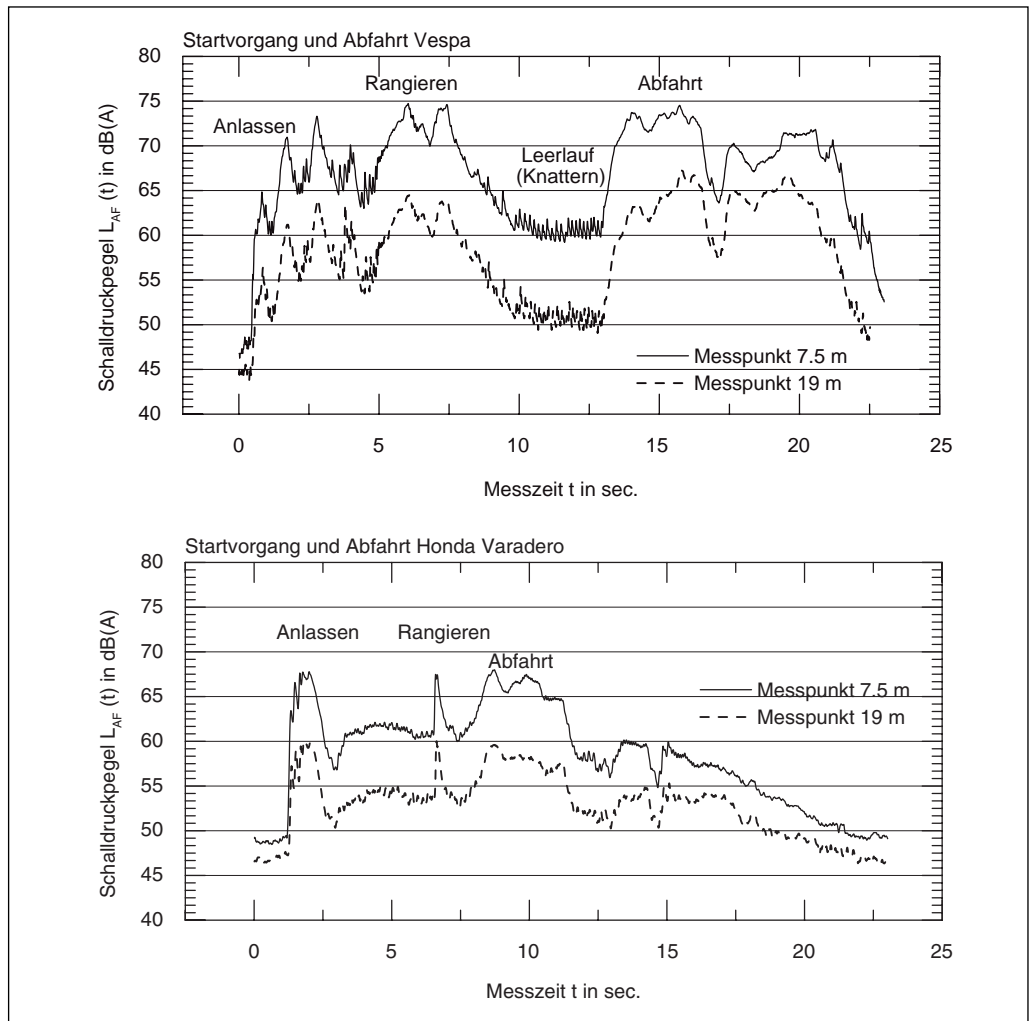


Fig. 18: Exemplary level-to-time diagrams of a scooter and of a motorcycle when leaving the carport (measuring points 7.5 m and 19 m)

6.1.2 Lorries of more than 2.8 t of Permissible Total Weight and Busses

For lorries, measurements of complete parking processes were performed in 2005. For that, processes of entering and leaving the carport (without shunting activities) took place in a lorry operation center on a farther remote carport. The examined lorries represent a typical cross section of the present vehicle fleet as lorry drivers being present at the recreation station were requested to simulate the parking processes with their lorry.

In analogy to the procedure of the motorcar measurements, the 7.5 measuring point served for the determination of the maximum levels of singular processes, whereas the 20 m measuring point served for the determination of the sound power levels

of complete parking processes. Fig. 19 shows the site plan. The measurements' results can be seen in Tab. 18 and Tab. 19. Examples of a process of entering and leaving a carport can be seen in fig. 20.

In comparison with the measurements of 1999, where the source levels of particular partial processes were summed up arithmetically to complete parking processes, it showed that for the measurements of the year 2005 slightly higher values were determined for L_{WTeq} and L_{Weq} than termed in [31] for low-noise lorries. On the other hand the maximum levels L_{AFmax} for the partial processes starting the engine, accelerated departure, shutting the door and deflating the compressed air have decreased.

Part of the lorries was labeled with the qualification sign (white "L" in the green circle) for low-noise vehicles according to the 28. amendment of the vehicle act execution regulation 1967 (Austria). None of the measured vehicles carried the qualification "low-noise vehicle" according to appendix XIV resp. XV of the Road Traffic Order ("StVZO") (Germany, white "G" in the green circle). The "low-noise" vehicles, however, to average don't show any relevant difference of the emission in comparison with the other vehicles. It can be supposed that these vehicles would likewise comply the requirements of low-noise vehicles. Therefore it was abstained from the differentiation low-noise resp. not low-noise subsequently.

For low-noise lorries, according to appendix XXI (of § 49, par. 3) StVZO, additional aggregates, e.g. pumps and fans, in a distance of 7 m must not be louder than 65 dB(A) and must not show a noise character containing tones or impulses.

The "parking area noise study" as a rule only deals with the noises caused by the entering and leaving of a carport. If not pure parking spots or parking areas for lorries but freight centers or operation facilities of forwarding agencies, frequently different noises are dominating around these, e.g. vent opening noises at the uncoupling of a lorry trailer. Concerning the noises being found on freight centers, it is referred to [22].

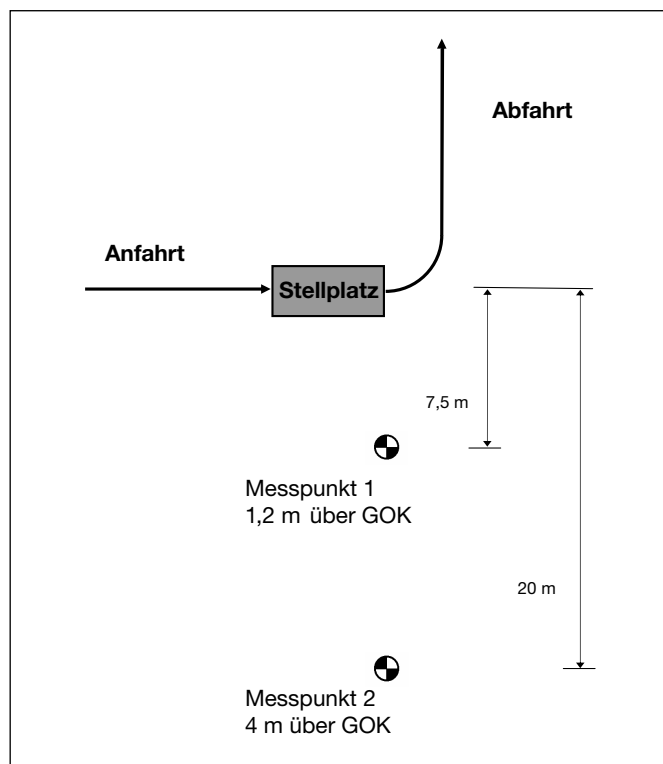


Fig. 19: Location outline of the sound level measurements of simulated parking processes of lorries

In the course of the sound level measurements of the year 1999 on a motorcar center, in addition the sound irradiation of cooling aggregates was measured (type "Thermo-King SMX II", Otto resp. diesel engine, controlled by thermostat, i.e. running time dependent on the outdoor temperature). In that, during the operation an average sound power level of the cooling aggregates of 97 dB(A) was found. As a rule, the running time of cooling aggregates is approx. 15 min. per hour. Further details can be found in [38].

The acoustic emissions of bus parking motions were measured at the bus station of Freising. For typical public service buses without acoustic striking features, one public service bus each with diesel drive and one public service bus each with natural gas impulse were chosen. Typical partial processes like door banging, accelerated departure, starting the engine etc. were measured in particular, as for these measurements no complete parking processes could be simulated. The sound power levels of the partial processes, determined from the measurements' results, were added up to one parking process arithmetically. The sound power levels of the single partial processes during the parking movements of the examined buses, determined metrologically, are listed in annex 6, the sound power levels of one parking movement per carport and hour, determined arithmetically, are listed in Tab. 18.

As can be seen from the measurements' results in annex 6 and in Tab. 18, for the two bus types a sound power level for 1 parking movement per hour is found which is lower compared to the details in [30].

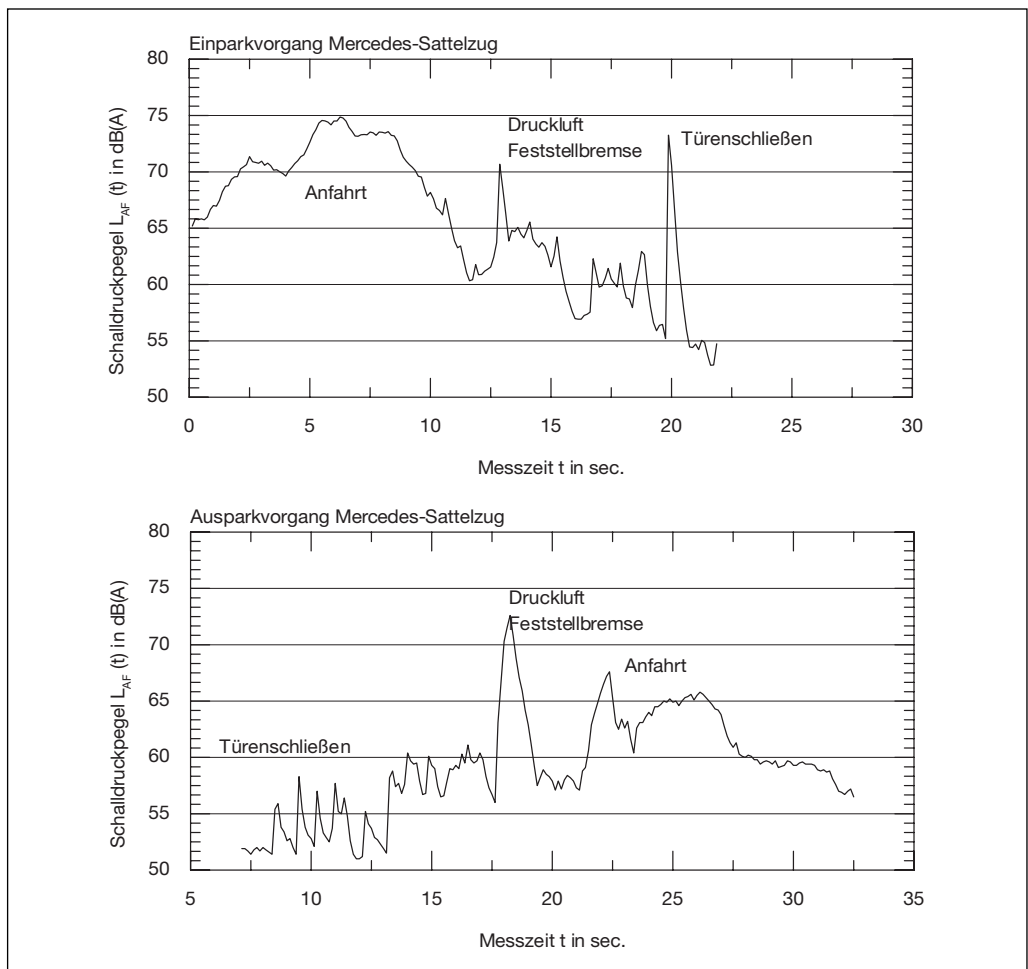


Fig. 20: Exemplary level-to-time diagrams of articulated lorries when leaving the carport (measuring point 20 m)

6.2 Measurements for the Determination of the Influence of Different Surfaces on the Driving Lanes

The measurements of the parking areas' sound power, described in sect. 6.1, were performed on parking areas with asphalted lane surfaces. Often however the driving lanes are not asphalted, but non-sealed or paved with a noise emission changed respectively. Because the surcharges for different road surfaces, termed in [5], Tab. 4, are not provided security for sufficiently for low speeds, as they appear on parking areas' driving lanes, the Bavarian State Agency for the Environment (LfU) has framed and implemented a measuring program for the determination of the surcharges dependent on the driving lanes' surfaces. The following surface types were incorporated in the investigation:

- Concrete block pavement (plane stone surface) with narrow joints ($\leq 3\text{mm}$),
- concrete block pavement (plane stone surface) with wide joints ($> 3\text{mm}$),
- gravel,
- refracted natural stone pavement (rough stone surface) with wide joints ($> 3\text{mm}$).

Because the surcharges represent the respective surface in relation to the "standard surface" asphalt, also this surface had to be recorded metrologically.

In order to get a measuring result as representative as possible, 4 different vehicle types of mixed years of construction, congruent to the actual vehicle fleet, were chosen.

As the measurements' attention was directed to the influence of the driving lanes' surface type, no complete parking processes were simulated (incl. door banging, starting etc.) but solely the traffic driving past was recorded. For that, the microphones were positioned in a lateral distance of 7.5 m to the lane's centre in a height of 1.2 m and 5 m. In order to take into account a possible influence of the driving-past-speed, too, the emission measurements were performed dependent on the speed for 10, 20 and 30 km/h with unchanging speed respectively, i.e. within the range recorded metrologically no procedure of accelerating or slowing down of the vehicle took place.

It showed that on parking areas a driving-past-speed of 30 km/h must be estimated as to be too high. In practice, depending on the parking areas' characteristics with regard to size, geometry and the carports' configuration, speeds from 10 km/h (traffic searching for carport) and 20 km/h (normal passaging traffic) are occurring.

Because in the so far investigations for the parking area noise study the equivalent level was the operative basic value, it is also used for the determination of the surcharge for the driving lanes' surfaces. From the arithmetical averaging of the differences between the driving-past-levels on pavement and gravel on the one hand and on asphalt on the other hand, with 10 and 20 km/h respectively, the following surcharges for the driving-past-equivalent-level could be calculated, related to the emission of asphalt driving lanes:

- 0 dB(A) for asphalt driving lanes,
- 0.9 dB(A) for concrete block pavement with joints $\leq 3\text{ mm}$,
- 1.4 dB(A) for concrete block pavement with joints $> 3\text{ mm}$,
- 4.1 dB(A) for water bound surfaces (gravel),
- 5.2 dB(A) for natural stone pavement.

The sound power of a parking area refers to complete parking processes, so that, apart from the traffic driving past, also other partial processes like e.g. door banging and starting must be taken into account in it. For further notices, look in sect. 7.1.6.

6.3 Measurements near the Ramps of Underground Car Parks

In the following the measurements` results at the examined underground car parks – two with enclosed (“closed”) and two with not enclosed (“open”) ramp respectively – are described and discussed. Fig. 21 shows a typical example of a not enclosed underground car park ramp.

Near the examined underground car parks, one measuring point was set opposite to the underground car park ramp and one lateral to the ramp respectively. In addition to the entering and leaving traffic of users of the underground car park carports, simulated drivings with different motorcars were performed for the sound level measurements.

As an illustration of the measuring conditions, in fig. 22 the location outline of the sound level measurements near the underground car park ramp is shown, with details of the site of the measuring points. Based on the measurements` results at the measuring points 1 and 2, the sound power levels and maximum sound levels near the underground car park ramp and near the arrivals and departures outside the ramp were determined.



Fig. 21:
Example of a not enclosed underground car park ramp

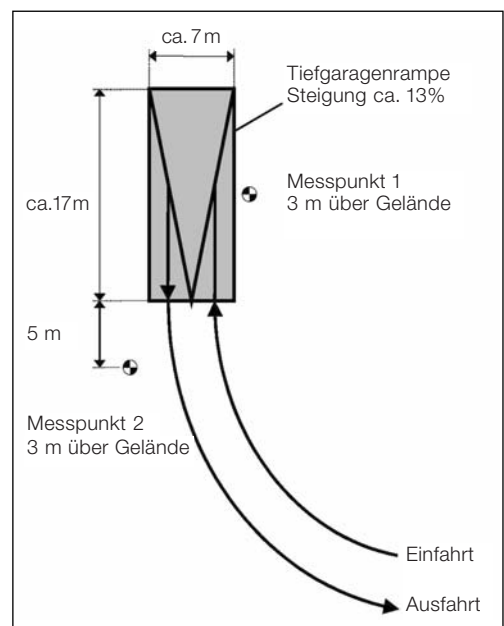


Fig. 22:
Exemplary location outline of the sound level measurements near a not enclosed underground car park ramp

Fig. 23 shows a typical example of a drain resp. rain gutter near an enclosed underground car park entrance.

In fig. 24.1, 24.2, 24.3 and 25, as an illustration of the sound engineering situation near the examined underground car park ramps, level-to-time diagrams of motorcars` arrivals and departures are listed. The noises containing impulse character when going over drain resp. rain gutters, not being sufficient for the state of the noise reduction art, can be recognized clearly in the level-to-time diagrams particularly during the arrivals.



Fig. 23:
Example of a drain resp. rain gutter near an enclosed underground car park entrance

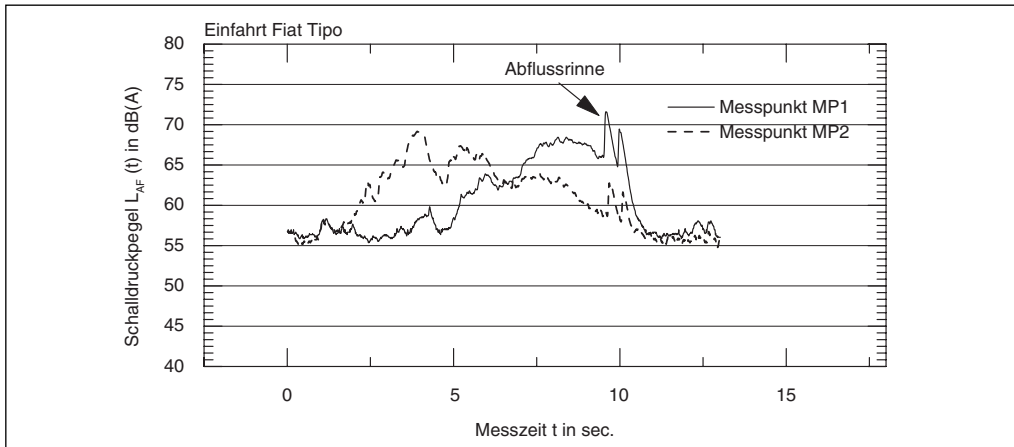


Fig. 24.1:
Exemplary level-to-time diagram of a not enclosed underground car park ramp

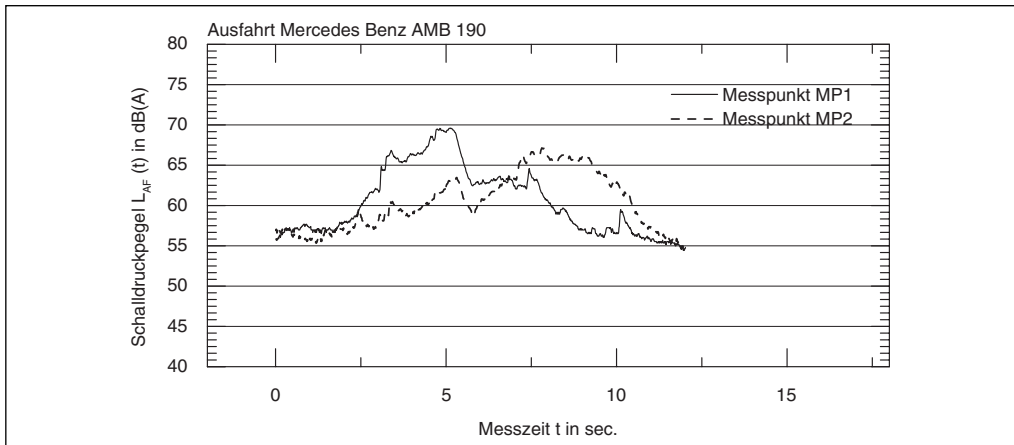


Fig. 24.2:
Exemplary level-to-time diagram of a not enclosed underground car park ramp

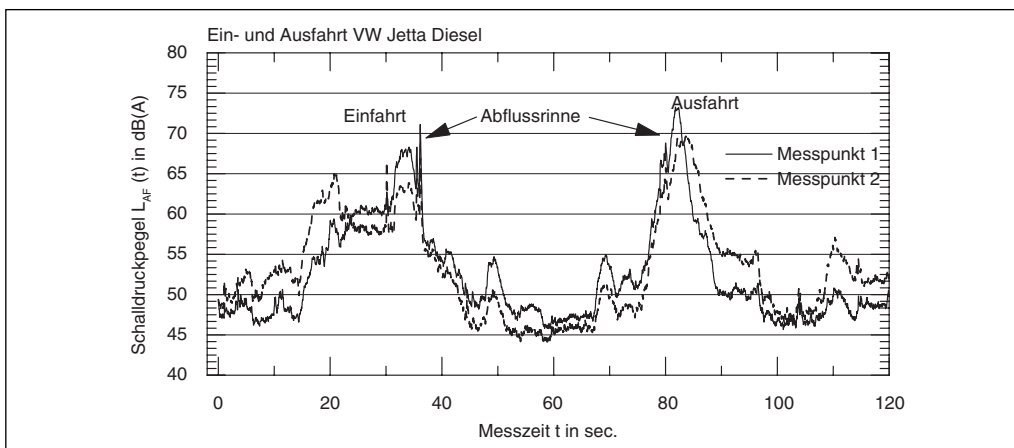


Abb. 24.3:
Exemplary level-to-time diagram of a not enclosed underground car park ramp

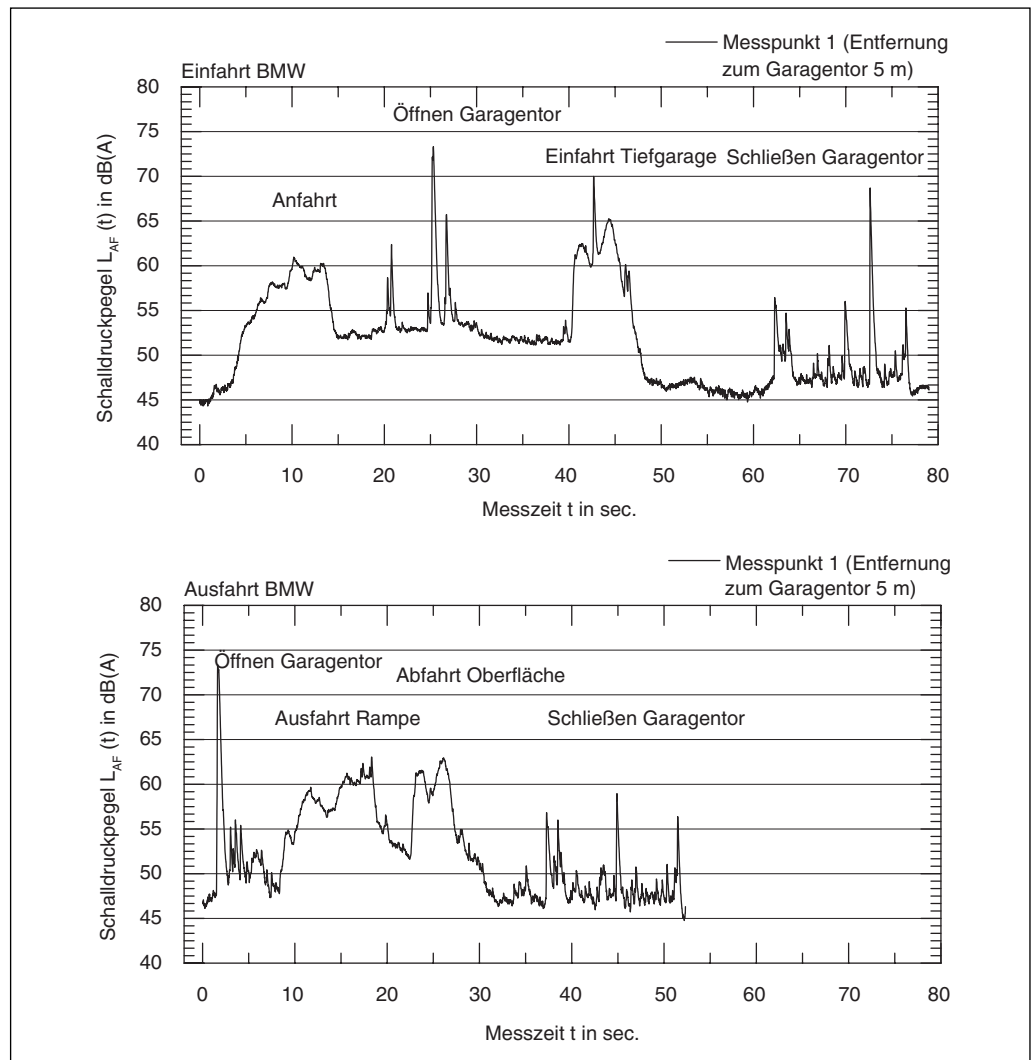


Fig. 25: Exemplary level-to-time diagrams near an enclosed underground car park ramp

6.3.1 Measurements` Results near not Enclosed Ramps of Underground Car Parks

For each one of the recorded arrivals and departures on “open” underground car park ramps, the equivalent levels per hour and the maximum sound levels were determined. Moreover, since the noise situation was recorded on digital tapes during the sound level measurements, the individual partial processes (arrival and departure on the ramp, approaching and leaving outside the ramp, passing over a rain gutter) could be evaluated. For every partial process the measurements` results of the individual drivings were averaged energetically.

Based on the equivalent levels per partial process and on the measuring conditions documented in the measurement report, the associated sound power levels were determined under consideration of the specifications of the DIN ISO 9613-2 [9].

In Tab. 20 and Tab. 21 the sound power levels determined based on the measurements` results are compiled; the measurements` results of the complete arrivals and departures are listed in annex 7.

The length-specific sound power levels of the approachings and leavings, determined by means of the sound level measurements, fall short of the sound power levels

Line acoustic sources $L_{W,1h}$ in dB(A)		Point acoustic source $L_{W,1h}$ in dB(A)
Driving noise level measured on the open ramp ³⁹⁾	Arrival resp. departure ⁴⁰⁾ (outside the ramp) according to [5] without D_{Stg}	Rain gutter ⁴¹⁾ (in front of the garage gate) acoustically striking
<i>Arrival to underground car park</i>		
51.0 (n=27)	46.1 (n=27)	60.3 (n=22)
<i>Departure from underground car park</i>		
52.1 (n=62)	47.2 (n=66)	62.9 (n=36)

Tab. 20:
Underground car park with an open ramp – sound power levels of one motorcar motion per hour, determined from sound level measurements
n = number of measurements

Driving noise level on the open ramp ⁴²⁾	Rain gutter ⁴³⁾ in front of garage gate
<i>Arrival to underground car park</i>	
87.1 (n=10)	99.6 (n=56)
<i>Departure from underground car park</i>	
93.1 (n=28)	100.5 (n=56)

Tab. 21:
Underground car park with an “open” ramp – sound power levels $L_{W,max}$ in dB(A) for short-time noise peaks, determined from sound level measurements
n = number of measurements

Plane acoustic source $L_{W,1h}$ in dB(A) Sound radiation through the open garage gate ⁴⁴⁾	Line acoustic source $L_{W,1h}$ in dB(A) Arrival resp. departure outside the ramp ⁴⁰⁾	Point acoustic sources $L_{W,1h}$ in dB(A) Rain gutter in front of the garage gate
<i>Arrival to underground car park</i>		
47.9 (n=24)	43.5 (n=23)	48.6 (n=19)
<i>Departure from underground car park</i>		
49.6 (n=13)	44.8 (n=15)	50.1 (n=8)

Tab. 22:
Underground car park with an enclosed ramp – sound power levels $L_{W,1h}$ of individual partial processes per hour, determined from sound level measurements;
n = number of measurements

Arrival resp. departure outside the ramp	Rain gutter in front of the garage gate	Opening or closing of a garage roller gate
<i>Arrival to underground car park</i>		
-	91.0 (n=19)	96.8 (n=16)
<i>Departure from underground car park</i>		
87.2 (n=15)	88.0 (n=8)	see arrival

Tab. 23:
Underground car park with an enclosed ramp – sound power levels $L_{W,max}$ in dB(A) for short-time noise peaks, determined from sound level measurements (state of the art not redeemed!)

Sound radiation through the open garage gate Enclosure's walls reflecting or absorbing	Number n of the measurements	Sound power level $L_{W,1h}$ in dB(A)
<i>Arrival to underground car park</i>		
Interior wall reflecting	5	50,4
Interior wall absorbing	4	46.0
<i>Departure from underground car park</i>		
Interior wall reflecting	6	54.1
Interior wall absorbing	6	52.6

Tab. 24:
Comparison of the sound power levels $L_{W,1h}$ of the driving noises on an underground car park ramp with reflecting resp. with absorbing enclosure, determined from sound level measurements

determined according to the calculation approaches of the RLS-90 [5]. According to bibliographical references, the average car speeds near underground car park ramps are lying at approx. 16 km/h for the arrival and at approx. 10 km/h for the departure [24]; according to the calculation approaches of the RLS-90, a minimum speed of 30 km/h is presupposed.

The road surfaces within the ramp zone were built up of paving stones, the lanes being profiled strongly as usual for the increase of the grip. Within the area of the approaching and leaving in front of the underground car park ramp, the road surfaces consisted partly of asphalt and partly of paving stones.

If the rain gutter's covering is made in a low noise form, e.g. with screwed cast iron sheets, it is not acoustically striking and therefore has not to be taken into account either.

6.3.2 Measurements` Results near Enclosed Ramps of Underground Car Parks

6.3.2.1 Underground Car Park Ramps with Reflecting Walls

In fig. 25 the sound engineering situation near the examined enclosed underground car park ramps is illustrated by means of commented level-to-time diagrams of a motorcar's arrival resp. departure. Within the area of the approaching and the leaving in front of the underground car park ramp, the road surfaces consisted mainly of asphalt and in sections of paving stones.

In analogy to the procedure for the not enclosed underground car park ramps, complete events of approaching and leaving as well as individual partial events were evaluated. In Tab. 22 and Tab. 23 the sound power levels of the partial events (equivalent levels of one hour and maximum levels for short-time noise peaks), determined on the basis of the measurements` results, are compiled; the measurements` results of the complete events of approaching and leaving are listed in annex 7.

The approachings` and leavings` length-specific sound power levels determined metrologically fall short of the sound power levels determined according to the calculation approaches of the RLS-90.

Since the sound level measurements were performed at two microphone positions opposite and lateral to the garage gate, evaluations about the direction characteristics of the sound radiation could be performed through the open garage gate. The plane-specific sound power levels listed in Tab. 22 were determined in a vertical direction to the garage gate; lateral to the garage gate (90° to the vertical direction), on the other hand, noise levels lower by about 8 dB(A) were measured.

At one of the examined underground car parks, significant noises could be recorded when opening and fastening the garage roller gate, which did not comply with the state of the noise reduction art (see fig. 25 and Tab. 23).

At a garage gate moved electromechanically, which complied with the state of the noise reduction art, by means of sound level measurements the following sound power levels of one opening process per hour could be determined, the garage gate being treated as a point acoustic source:

$$L_{W\text{Teq}, 1\text{h}} = 45 \text{ dB(A)},$$

for short-time noise peaks:

$$L_{W, \max} = 76 \text{ dB(A)}$$

Near the examined enclosed underground car park ramps, in comparison with the open ramps lower sound power levels showed when approaching and leaving in front of the gradient and when going over a rain gutter. If the rain gutter's covering is made in a low-noise form, e.g. with screwed cast iron sheets, it is not acoustically striking and therefore has not to be taken into account either.

6.3.2.2 Underground Car Park Ramps with Absorbing Walls

In order to determine metrologically the influence of the sound absorbing panelings of underground car park ramps, in the year 2005 comparing measurements near two enclosed underground car park ramps, one with reflecting inner walls and one with absorbing inner walls, were performed.

Both underground car park ramps show the equal single-lane cross section of approx. 3.5 m x 2.5 m. While the reflecting enclosure completely consisted of slick concrete, the lateral inner walls of the absorbing enclosure were paneled with wood wool laminated boards. The ceiling of the absorbing enclosure was performed with single-shell sheet metal (reflecting). In both cases the road surface consisted of reflecting concrete.

Fig. 26 shows the inner wall, paneled with wood wool laminated boards, of the underground car park ramp performed in an absorbing manner.

The measurements were performed with an array of the microphones comparable to measuring point 2 in fig. 22. In order to eliminate the influences of the rain gutters existing on both ramps (with distinct noises) and of the approaching outside the ramp, which was not influenced by the absorbing paneling, the driving noises on the ramp were isolated in the evaluation. Near both underground car park ramps, entering and leaving events with 3 different motorcars (2 vehicles with Otto engine, 1 vehicle with diesel engine) were simulated. The measurements' results are shown in Tab. 24.

It shows that the measured sound power level on the underground car park ramp, paneled in an absorbing manner, is lower by 4.4 dB(A) when entering and by 1.5 dB(A) when leaving. Averaged over the entering and the leaving process, the difference between reflecting and absorbing enclosure of the ramp is rounded 2 dB(A).



Fig. 26:
Inner wall of the underground car park ramp, paneled in an absorbing manner

6.4 Measurements near Multi-Storey Car Parks

In the following the results of the sound level measurements near the examined multi-storey car parks are described and discussed.

The measurements were performed near two open multi-storey car parks and near one with a parking level. Multi-storey car parks, which are marked by the radiation of the multi-storey car park's parking noises through for the most part open lateral faces, in the present study are denoted as to be "open". Since the open coverage type of multi-storey car parks makes possible a cost-effective ventilation and degassing, it is chosen as a rule. A typical example of an "open" multi-storey car park is shown by fig. 27.



Fig. 27:
Example of an open
multi-storey car par

For a simultaneous recording of the parking noises within the multi-storey car parks and outside the radiating lateral faces, microphones were positioned respectively within and outside the multi-storey car parks. In addition to the motorcar drivings and parking processes of users of the multi-storey car parks, for the sound level measurements simulated parking processes were performed in a distance of 7.5 m from the microphone position inside the multi-storey car park. Moreover, at an outside measuring point in a distance of 2 m from the outer wall of the multi-storey car park, the parking noises were recorded. In that, different motorcars were used.

As an illustration of the measuring conditions, in fig. 28 the location outline of the sound level measurements is listed, with details of the position of the measuring points.

In Tab. 25 and fig. 29 a typical octavo spectrum of the parking noises at the "measuring point inside" is given. This spectrum of the energetic mean average value of the noise level was determined during sound level measurements over a period of 30 minutes near a highly visited multi-storey car park without sound decreasing measures (e.g.: absorbing ceilings).

The level differences between the measuring points "inside" and "outside" are approx. 7 dB(A) for the equivalent level and approx. 10 dB(A) for the maximum level of short-time noise peaks.

In analogy to the procedure of the "free field measurements" (see sect. 6.1.1), in the examined multi-storey car parks sound level measurements of simulated parking processes with different motorcars were performed, as mentioned. The measurements' results of the simulated parking processes in the examined multi-storey car parks are listed in annex 8.

Due to the sound reflections at the ceiling, on the ground and the walls in the multi-storey car park, the noise level during one parking movement in the multi-storey car

	Octavo mid frequency in Hz							
	63	125	250	500	1000	2000	4000	8000
Sound level difference $L_{AFeq} - L_{AFeq, Octavo}$ in dB(A)	-17.7	-17.1	-12.8	-8.7	-5.3	-4.6	-9.4	-19.6
L_{AFeq} in dB(A)	61.8							

Tab. 25: Measurement in an open multi-storey car park – typical octavo spectrum at the measuring point inside

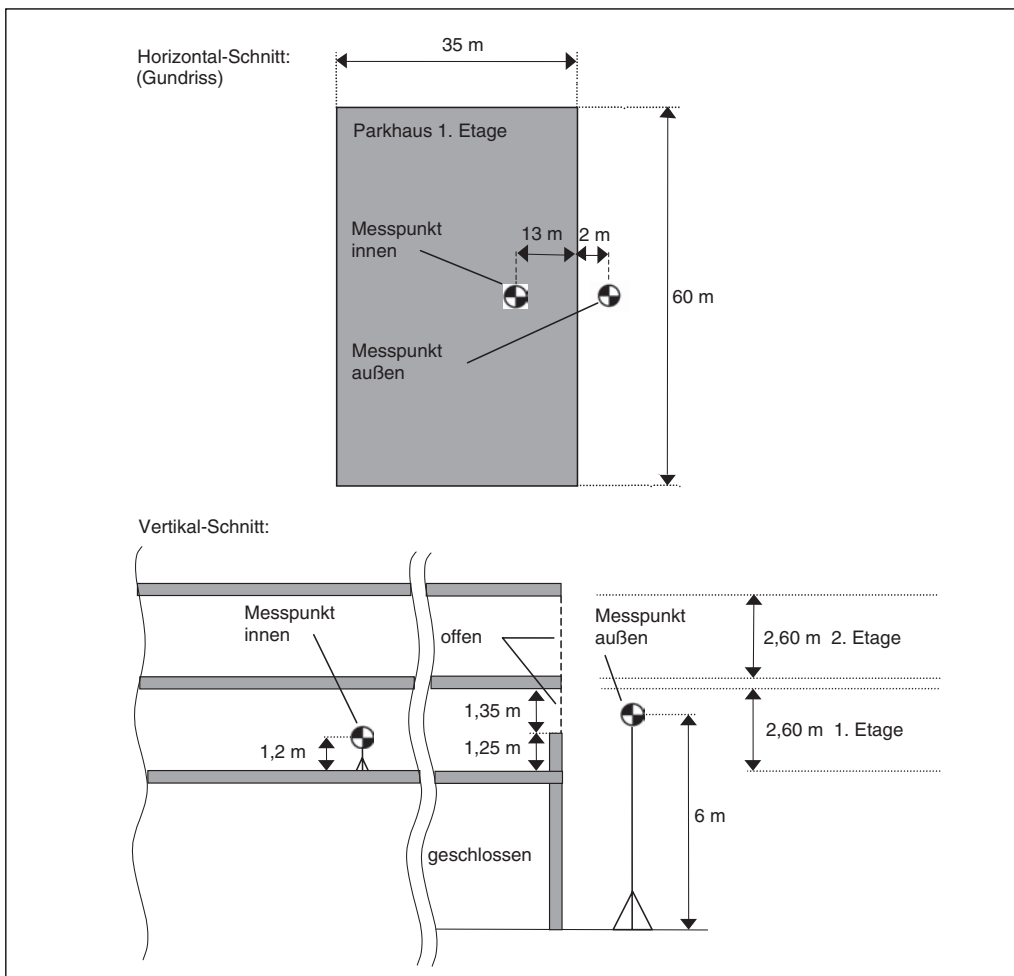


Fig 28: Location outline of the sound level measurements near an open multi-storey car park

	Meas. duration [sec.]	L_{AFmax} [dB(A)]	L_{AFeq} [dB(A)]	L_{AFTeq} [dB(A)]	$K_1^{45)}$ [dB(A)]
Measuring point inside ⁴⁶⁾	1800	82.3	61.8	66.8	5.0
Measuring point outside ⁴⁶⁾	1800	72.3	54.8	59.9	5.1
Counting results	Number of vehicle motions: 36			Frequency of motion per carport and hour: 0.59	

Tab. 26: Exemplary measuring and counting results near an open multi-storey car park (cp. fig. 27) – comparison measuring point inside – measuring point outside

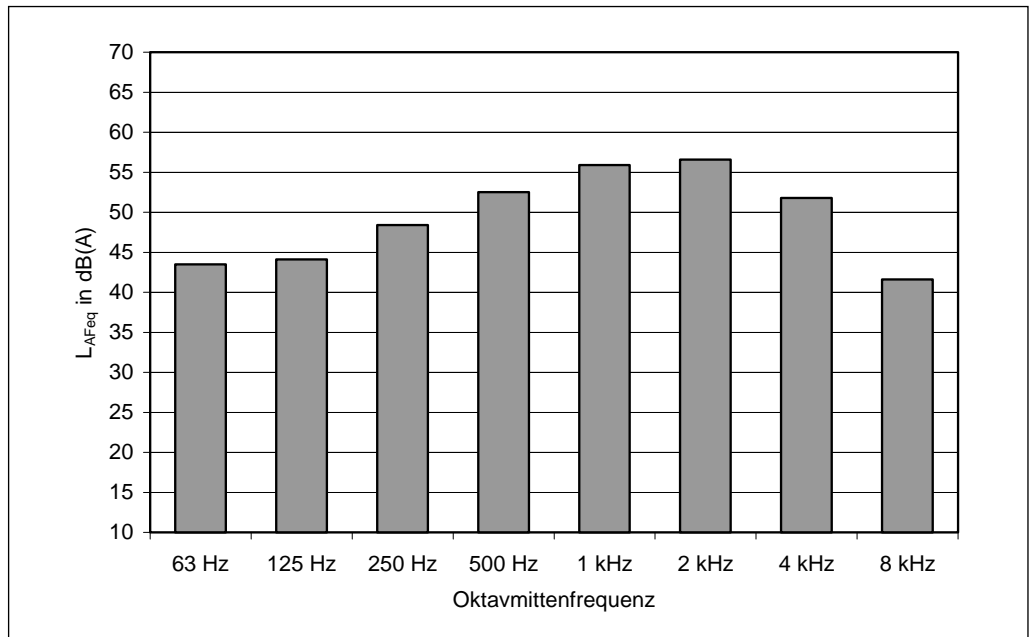


Fig. 29: Measurement in an open multi-storey car park – typical octave spectrum measuring point inside

park is increasing as a rule in comparison with the comparable situation in the open, this level difference being dependent, among others, on the space geometry and the absorption qualities of the limiting planes.

In Tab. 27 the increases of the noise level, found out metrologically near the examined multi-storey car parks, during one parking movement in the multi-storey car park are given, in comparison with the comparable situation in the open.

In sect. 7.3 a calculation procedure for the sound engineering forecast of multi-storey car parks is developed whose practical suitability is checked by means of the described measurements` results.

Tab. 27: The interior sound level`s increase, determined metrologically during one parking movement inside the multi-storey car park, in comparison with one parking movement in the open

Type of multi-storey car park	Noise level increase
Open multi-storey car park without sound decreasing measures	+ 9 dB(A)
Open m.-s. c. p. with parking level with a sound absorbing ceiling	+ 2 dB(A)
M.-s. c. p. basement without acoustically relevant openings resp. underground car park without sound decreasing measures	+ 9 dB(A)

7 Details of Sound Emission Calculation

7.1 Parking Areas

7.1.1 Fundamentals of the Calculation Method

The methods for the calculation of the sound emissions by parking areas' noises are represented in chapter 7 with regard to individual details and in chapter 8 in summarized form (formulas 11a and 11b). After all, these formulas constitute a further expansion of the formula 7 in DIN 18005-2 (edition May 1987) [13].

Two methods are discerned:

- the integrated calculation method where the partial sound sources of the movements of entering and leaving a carport as well as of the traffic on the driving lanes (so called passaging traffic share) are summed up to one plane acoustic source, and
- the separated method which takes into account the sound emissions of the movements of entering and leaving a carport as well as of the passaging traffic share separately. The calculation of the passaging traffic share is done according to RLS-90.

In the integrated calculation method, the passaging traffic share in the formula of the plane-specific sound power level's calculation is set in a way that the rating levels computed with it are lying on the safe side, thus being somewhat higher than when using the separated calculation method which should be used only if the volume of traffic on the individual driving lanes can be prognosticated to some extent reliably, e.g. for parking areas with the shape of a blind alley. In all other cases, the separated calculation method as a rule would not give more exact results than the integrated calculation method.

In the integrated calculation method, the passaging traffic share in the formula of the plane-specific sound power level's calculation is set in a way that the rating levels computed with it are lying on the safe side, compared with the separated calculation method.

7.1.2 Passaging Traffic Share in Case of the Integrated Method

In the sound level measurements explained in the sect. 6.1, only the arrivals and departures belonging to the actual parking process were recorded. Not taken into account were the "passaging processes" of other vehicles on the parking area from and to the carport and also a possible "traffic searching for carports" which can have a considerable extent in the case of parking areas dimensioned too small. The driving lanes' volume of traffic furthermore is dependent on the shape of the parking area, on the number and position of the entrances and exits, on the sequence of the carports' occupancy and on other factors, and therefore – apart from some exceptions – cannot be prognosticated with a simple mathematical relation in a sufficiently exact way. For example, at a parking area near a shopping center first the carports nearby the entrance are occupied. For these carports the number of the motions per carport and hour is higher than for more unfavourably situated ones.

It also can happen that near a parking area no traffic searching for carports appears, e.g. near bus stops or near small private parking areas where every vehicle has its own reserved carport.

Since the 3rd edition of the parking area noise study [30], the passaging traffic

share is taken into account generally by an additional term, a proximity formula. This term in the so called integrated method was reviewed and developed newly, because it is not only dependent on the carports` number, as so far presumed, but also on the intensity of their use, i.e. on the value $N = \text{“vehicle motions per carport and reference value”}$, i.e. not only the partial rating levels of the movements of entering and leaving a carport but also the partial rating levels of the passing traffic on the parking area are dependent on the reference value.

Sound engineering calculations were performed for 10 parking areas, each differently large (with 20 to 1260 carports) and for as a whole 5 parking area types, for quieter and for louder immission sites respectively (the latter near the entrance), in order to be able to develop a new formula for the passing traffic share. The passing traffic share was found to be the linear difference between the over-all rating level, determined energetically from the process of entering and leaving a carport, and the traffic searching for carport minus the partial rating level of the entering and leaving of a carport. Naturally, the results of the passing traffic share were oscillating heavily with the motions/reference value associated to it, depending on the immission site`s position and on the parking area type. Due to the passing traffic share`s relation not to the motions per reference value and hour, found out for the parking area type, but to the average number of carports per unit of the reference value, it was succeeded to develop a convenient empirical formula. It goes as follows:

Formula 3

$$K_D = 2.5 \cdot \lg (f \cdot B - 9) \text{ dB(A);}$$

$f \cdot B > 10$ carports; $K_D = 0$ for $f \cdot B \leq 10$

K_D = level increase due to the passing traffic and the traffic searching for carport [dB(A)];

f = carports per unit of the reference value (cp.Tab. 3), e.g. in the case of discotheques: $f = 0.50$ carports/1 m² net restaurant room

B = reference value (= carports, net selling area, net restaurant room or beds)

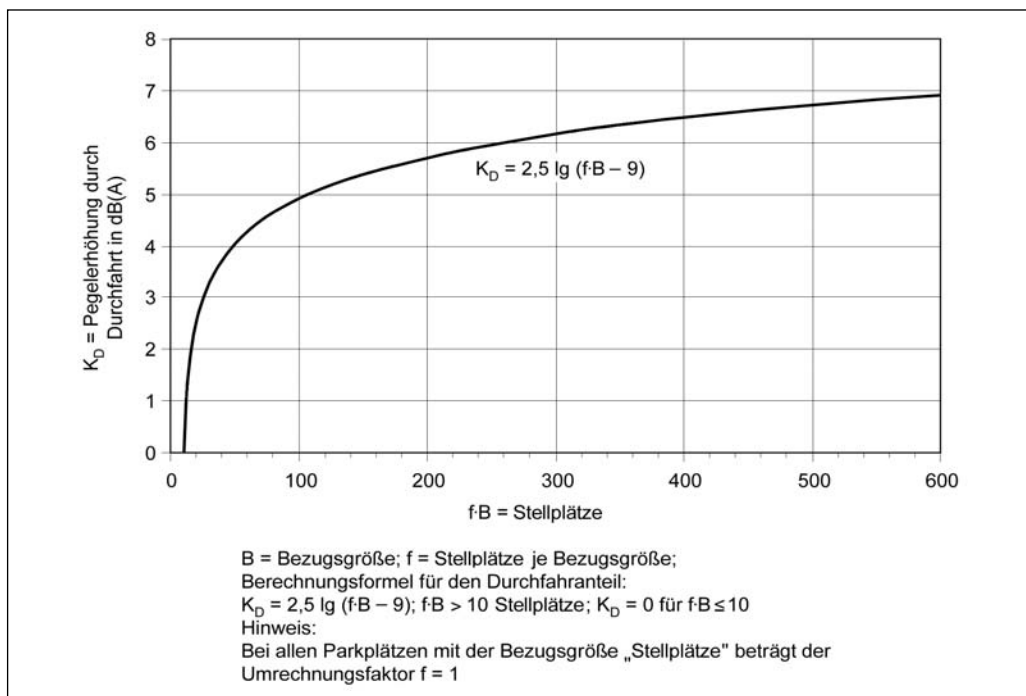


Fig. 30:
Passaging traffic share for the P + R area depending on the number of carports

Thus an average value for the passing traffic share can be considered. The inclusion of the average number of carports per unit of the reference value is yielding results lying lower in the case of oversized parking areas, in the case of undersized parking areas however higher than if considering solely the carports. The level increase K_D due to the passing traffic and the traffic searching for carport is exemplary shown by the figures 30 and 31, fig. 30 for the P + R area depending on the carports` number, fig. 31 depending on the net selling area.

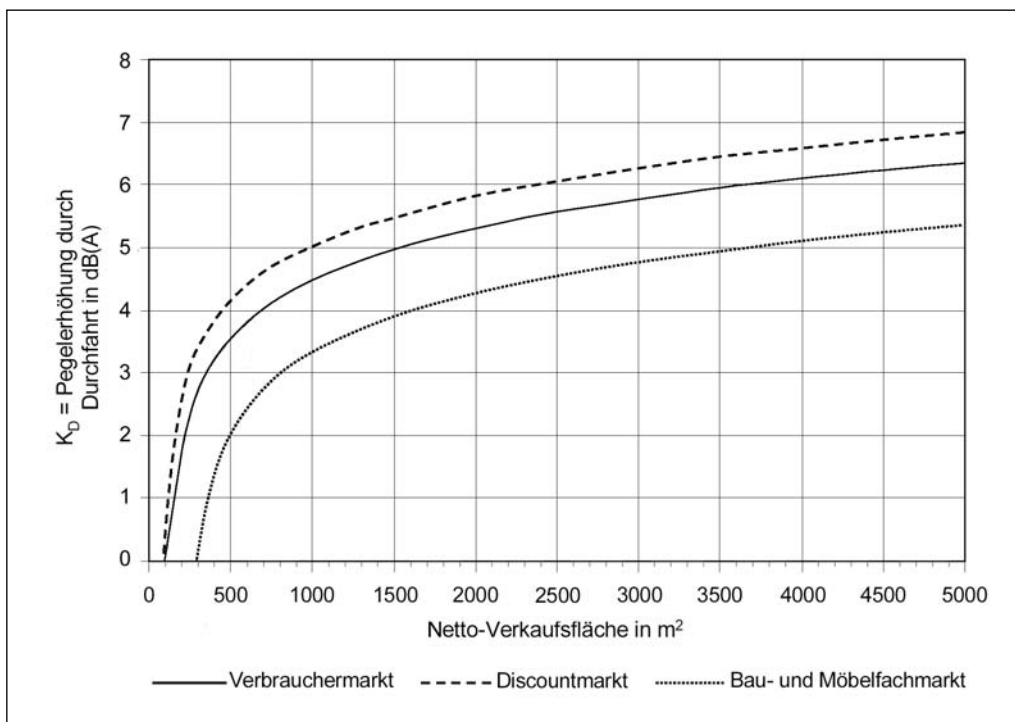


Fig. 31: Passing traffic share for parking areas near various purchase markets on the reference value "net selling area"

7.1.3 Separated Calculation Method

The length-specific sound power level of the passing traffic must be determined by means of the sound emission level $L_{m,E}$ according to RLS-90 [5] and according to the following connection:

$$L_{W', 1h} = L_{m,E} + 19 \text{ dB(A)}$$

Formula 4

In that, a driving speed of 30 km/h must be set and the sound propagation must be calculated according to TA Lärm [2] according to the norm DIN ISO 9613-2 [9]. At the sound immission site, the acoustic shares of the different partial areas and of the driving lanes, taken into account separately, are added up energetically.

With the possibilities of the electronic data processing existing today (see also [20]), using this calculation method you can examine very well the effects of different planning variants, such as, e.g., the shifting of an entrance, on the sound immission sites with relatively low effort.

7.1.4 Surcharges for Impulse Character (K_I and K_I^*)

In the case of noises containing impulse character, in accordance with TA Lärm the stroke maximal level has to be used in which the surcharge for the impulse character is defined to be the difference of the equivalent level according to the stroke maximal level method and of the equivalent level without consideration of the stroke maximal level method (TA Lärm [2], sect.. A.3.3.6).

K_I^* (cp.Tab. 18 and Tab. 28) was determined in a distance of 7.5 m without the influence of the traffic searching for carport. Since the noises of the traffic entering and leaving a carport are always occurring together with those of the traffic searching for carport, the surcharge for impulse, which must be taken for a forecast calculation, is clearly lower than K_I^* . Therefore in the case of the separated calculation method, for the calculation of the partial rating level of the entering and leaving of a carport also the surcharges K_I listed in Tab. 29 are taken.

Tab. 28:
Surcharges K_I^* for the impulse character (traffic entering and leaving a carport without traffic searching for carports)

Parking area type	K_I^* in dB(A)	Remarks
P + R area	7.4	
Parking area near a purchase market	7.6	Shopping trolleys on asphalt
	7.2	Shopping trolleys on paving stones
Parking area near a discotheque	7.4 ⁴⁷⁾	
Central bus stop	4.3 ⁴⁸⁾	Standard bus
	3.4 ⁴⁹⁾	Low corridor citybus (natural gas)
Car center for lorries	4.2	
Motorcycle parking area	4.9	

The surcharge K_I for the stroke maximal level method is depending on the passing traffic share also. Since however a surcharge should be developed that can be handled as simply as possible, for this, within the scope of this study, for each parking area type a value was assumed that can be found frequently in practice. In the Tab. 29, for the individual parking area types the number of the carports, for which the level increases were calculated, and the (rounded) surcharges K_I are listed.

Strictly speaking, this surcharge for the stroke maximal level method – determined for the distance of 19 m – should also be made dependent on the distance emission site – immission site, since, with increasing distance from the source, the short-time

Tab. 29:
Surcharges K_I for the impulse character (parking process including passing traffic share)

Parking area type	Number of carports	K_I in dB(A)	Remarks
P + R area	100	4	
Parking area near a purchase market	150	4	Shopping trolleys on asphalt
	150	5	Shopping trolleys on paving stones
Parking area near a discotheque	100	4	
Central bus stop	10	4	Standard bus
	10	3	Low corridor citybus (natural gas)
Car center for lorries	20	4	
Motorcycle parking area	10	4	

noise peaks are protruding over the back basic noise less and less, and with that the difference between equivalent level and stroke maximal level becomes smaller and smaller. In order not to make the parking area formula unnecessarily complicated, we neglect this effect and look at the calculation results, due to this actually being a little too high, as a contribution to a "calculation on the safe side".

7.1.5 Surcharges for the Parking Area Type (K_{PA})

In Tab. 30, the sound power levels L_{W0} , determined metrologically for the individual parking area types, are summarized (respectively for one motion per hour); see also Tab. 18.

Parking area type	L_{W0} in dB(A)	Remarks
P + R area	62.7	
Parking area near a purchase market	65.4	Shopping trolleys on asphalt
	67.2	Shopping trolleys on big stones with lawn joint
Parking area near a discotheque	64.6 ⁴⁸⁾	
Central bus stop	72.8 ⁴⁹⁾	Standard bus
	69.9 ⁴⁹⁾	Low corridor citybus (natural gas)
Parking space resp. car center for lorries	77.0	
Motorcycle parking area	65.7	

Tab. 30:
Sound power levels L_{W0} , determined metrologically, for one motion per carport and hour

For the initial sound power level L_{W0} of one motion per carport and hour on a P + R area, in the following the (rounded) value of 63 dB(A) is set. The different sound power levels of the individual parking area types are taken into account within the calculation method by rounded surcharges K_{PA} according to Tab. 31 and Tab. 34, compared with the quietest of the tested parking areas, the P + R area.

Parking area type	K_{PA} in dB(A)	Remarks
P + R area	0	
Parking area near a purchase market	3	Standard shopping trolleys
	5	
Parking area near a purchase market	3	Low noise shopping trolleys
	3	
Parking area near a discotheque	4 ⁵⁰⁾	
Central bus stop	10	Standard bus
	7	Low corridor citybus (natural gas)
Parking place resp. car center for lorries	14	
Motorcycle parking area	3	

Tab. 31:
Surcharges K_{PA} for the parking area type

7.1.6 Surcharges for Different Surfaces on the Driving Lanes (K_{StrO} und K_{StrO}^*)

The surcharges for different lane surfaces given in sect. 6.2 merely refer to the driving-past level so that these values, rounded in the following list, can be taken only in the so-called "separated method" (special case) for the determination of the sound emissions of the traffic searching for carports and the passaging traffic according to RLS-90. K_{StrO}^* takes the place of the correction D_{StrO} in Tab. 4 of the RLS-90 [5].

Surcharge K_{StrO}^* only for the partial rating levels "driving lanes" in the case of the separated calculation method (special case):

- 0 dB(A) for asphalt driving lanes,
- 1.0 dB(A) for concrete block pavement with joints ≤ 3 mm,
- 1.5 dB(A) for concrete block pavement with joints > 3 mm,
- 4.0 dB(A) for water bound surfaces (gravel),
- 5.0 dB(A) for natural stone pavement.

Since the driving-past procedure is only one partial procedure of one complete parking process, a progressing induction of this surcharge into the basic calculation approach for the normal case, i.e. for the "separated method", must be performed. For that, we go back to measurements which are reported in [30]. Here, by addition of the individual partial sound power levels of the partial procedures, the total sound power level of the parking process on asphalt is determined. By increasing the partial sound source driving-past by the above-mentioned surcharge K_{StrO}^* , for the total parking process (resp. for one parking motion) and for different lane surfaces the sound power level, increased by the surcharge K_{StrO} , can be determined.

Surcharge K_{StrO} in the case of the integrated method (normal case):

- 0 dB(A) for asphalt driving lanes,
- 0.5 dB(A) for concrete block pavement with joints ≤ 3 mm,
- 1.0 dB(A) for concrete block pavement with joints > 3 mm,
- 2.5 dB(A) for water bound surfaces (gravel),
- 3.0 dB(A) for natural stone pavement.

7.2 Underground Car Park Ramps

7.2.1 General Remarks

In order to develop a computational model of the sound engineering situation of underground car parks it is useful to differentiate the complete situation into the following partial procedures:

"closed" underground car park (ramp enclosed):

- Approaching and leaving traffic outside the underground car park ramp,
- sound radiation through open garage gate during arriving and leaving procedure,
- potentially further sound sources (passing over a rain gutter, noises when opening a garage roller gate etc.),

“open” underground car park (ramp not enclosed):

- Approaching and leaving traffic outside the underground car park ramp,
- traffic on the ramp,
- potentially further sound sources (passing over a rain gutter, noises when opening a garage roller gate etc.).

7.2.2 Approaching and Leaving Traffic, Traffic on not Enclosed Ramps

The measurements` results near not enclosed underground car park ramps, represented in sect. 6.3.1, show that a calculation of the approaching and leaving traffic`s sound emissions according to the RLS-90 [5] is lying on the “safe” side.

For a calculation method as simple as possible, the length-specific sound power level of the approaching and leaving traffic as well as of the traffic on not enclosed ramps is determined by means of the sound emission level $L_{m,E}$ in accordance with the RLS-90 according to the following connection:

$$L_{W', 1h} = L_{m,E} + 19 \text{ dB(A)}$$

Formula 4

When calculating the source level $L_{m,E}$ according to RLS-90, a driving speed of 30 km/h is used. The slope of the underground car park ramp, possible corrections for different lane surfaces (RLS-90, table 4) as well as the number of vehicle motions per hour must be taken into account when calculating the source level $L_{m,E}$ in accordance with the specifications of the RLS-90. The sound propagation is calculated in accordance with TA Lärm [2] according to the norm DIN ISO 9613-2 [9].

The noise character of the approaching and leaving traffic is classified as containing no impulse; thus a surcharge for the stroke maximal level method isn't necessary. The noise containing impulse character when passing over a rain gutter is treated separately (see below); without impulse surcharge, the contribution of the rain gutter to the equivalent level is small due to the short length of time.

For a consideration of short-time noise peaks due to the approaching and leaving traffic, based on the measurements` results the sound power levels of point acoustic sources listed in Tab. 21 and Tab. 23 were determined.

To sum up, the following sound power levels of short-time noise peaks by the approaching and leaving traffic are found:

“open” ramp, ramp zone:

- entrance: $L_{W, \max} = 87.1 \text{ dB(A)}$
- exit: $L_{W, \max} = 93.1 \text{ dB(A)}$

“closed” ramp, in front of garage gate:

- exit: $L_{W, \max} = 87.2 \text{ dB(A)}$

If necessary, emissions of motorcycles must also be taken into account (cf. also sect. 8.3.1).

7.2.3 Sound Emission through Open Garage Gate in Case of Enclosed Ramp

In Tab. 22 the plane-specific sound power levels of the sound radiation through the open garage gate of a motorcar's approaching resp. leaving, found out metrologically, were listed. In addition the directivity character was determined metrologically: compared with the direction perpendicular to the garage gate, lateral to the garage gate (90° to the perpendicular direction) noise levels lower by about 8 dB(A) were measured.

To sum up, the following measurements' results of the sound radiation through an open garage gate are found (one vehicle motion per hour each):

entrance:

$$L_{W', 1h} = 47.9 \text{ dB(A)} ; dL(90^\circ) = - 8 \text{ dB(A)}$$

exit:

$$L_{W', 1h} = 49.6 \text{ dB(A)} ; dL(90^\circ) = - 8 \text{ dB(A)}$$

In the following, the determined measurements' results, for the further examination, are confronted with mathematical approaches.

The source levels which can be expected near the opening of the approaching resp. leaving traffic are calculated based on a method for tunnel portals listed in [32], since the sound engineering situation being present here can be compared with that of a tunnel portal.

In accordance with [32], due to reflections in the middle of the tunnel the sound level is increased by Δ_L [dB] according to the following formula:

$$\Delta_L = 10 \cdot \lg \cdot \left[1 + 2,5 \cdot \left\{ \sqrt{1 + \left(\frac{SR}{1 + \alpha \cdot SR} \right)^2} - 1 \right\} \right]$$

(6)

with

$$SR = 0,5 \cdot \frac{S}{r}$$

r = radius of a semicircle whose area corresponds to the tunnel cross-sectional area,
 s = tunnel length,
 α = average coefficient of absorption of the tunnel walls.

In the present case, in the middle of the two enclosed underground car park ramps a mathematical increase of the noise level due to reflections was found to be $\Delta_L = 8.8 \text{ dB(A)}$

with: $r = 1.92 \text{ m}$ resp. 2.14 m ; $s = 20.8 \text{ m}$ resp. 23.4 m und $\alpha = 0,1$.

The sound level, being expected in the middle of the respective enclosed underground car park ramp (for a free sound propagation) in the distance r , due to the reflections was increased by $\Delta_L = 8.8 \text{ dB(A)}$ resp. $\Delta_L = 8.9 \text{ dB(A)}$, and the plane-specific sound power level of the approaching resp. leaving traffic's opening was determined from the interior sound level ⁵¹).

The sound power levels, calculated according to the above-mentioned calculation method, are on average by about 1.9 dB(A) lying above the values found metrologically, the source emissions near the ramp being calculated according to the RLS-90, see sect. 6.3.1.

Near open underground car park ramps with the garage gate below the ramp, the sound radiation through the open garage gate was negligible in the case of the examined underground car park ramps compared with the driving noise on the ramp.

Formula 6

The method for the calculation of the sound emission of tunnel portals, listed in [32], therefore delivers results on the "safe" side near the approaching resp. leaving traffic's openings of the two examined enclosed underground car park ramps.

For a sound engineering forecast it is suggested to set the measured values found within the framework of this study. In the case of a sound absorbing style of the interior walls of the enclosed underground car park ramps, values decreased by 2 dB(A) can be expected. When the local conditions near the underground car park ramp, that has to be assessed, are differing from the situation near the ramps examined metrologically, the above-mentioned computational method can be used delivering results on the "safe" side.

7.2.4 Passing over a Rain Gutter

If the rain gutter's covering is made in a low noise form, e.g. with screwed cast iron sheets, it is not acoustically striking and therefore has not to be taken into account either.

If the covering is not performed according to the state of the noise reduction art, the following considerations have to be taken into account. In Tab. 21 and Tab. 23 the sound power levels of short-time noise peaks when passing over of a not low noise rain gutter, determined metrologically, are listed.

The sound power level per hour according to the stroke maximal level method ($L_{WTeq, 1h}$) can be calculated based on the maximum sound power levels listed in Tab. 21 and Tab. 23 under consideration of the 5 sec.-stroke of the stroke maximal method as follows:

$$\begin{aligned} L_{WTeq, 1h} &= L_{W, max} + 10 \cdot \lg (5 \text{ sec.} / 3600 \text{ sec.}) \\ &= L_{W, max} - 28.6 \text{ dB(A)} \end{aligned} \quad \text{Formula 7}$$

The following sound power levels therefore arise when passing over a rain gutter (one vehicle motion per hour each):

- "open" ramp (rain gutter below the ramp):

entrance:

$$L_{WTeq, 1h} = 71.0 \text{ dB(A)} \quad L_{W, max} = 99.6 \text{ dB(A)}$$

exit:

$$L_{WTeq, 1h} = 71.9 \text{ dB(A)} \quad L_{W, max} = 100.5 \text{ dB(A)}$$

- "closed" ramp (rain gutter above the ramp):

entrance:

$$L_{WTeq, 1h} = 62.4 \text{ dB(A)} \quad L_{W, max} = 91.0 \text{ dB(A)}$$

exit:

$$L_{WTeq, 1h} = 59.4 \text{ dB(A)} \quad L_{W, max} = 88.0 \text{ dB(A)}$$

7.2.5 Opening or Closing a Garage Roller Gate

Near one of the examined underground car parks, significant noises when opening and closing the garage roller gate could be noted (see fig. 25). In Tab. 23 the sound power levels of short-time noise peaks when opening the garage roller gate, determined metrologically, are listed.

Due to this noise's impulse character, the sound power level per hour again can be calculated according to the stroke maximal level method ($L_{WTeq, 1h}$), based on the above-mentioned maximum sound power levels under consideration of the 5 sec.-stroke of the stroke maximal method, as follows:

Formula 7

$$\begin{aligned} L_{WTeq, 1h} &= L_{W, max} + 10 \cdot \lg (5 \text{ sec.} / 3600 \text{ sec.}) \\ &= L_{W, max} - 28.6 \text{ dB(A)} \end{aligned}$$

To sum up, the following sound power levels when opening resp. closing the garage roller gate (one process per hour), which don't correspond to the state of the noise reduction art, are found:

$$L_{WTeq, 1h} = 68.2 \text{ dB(A)} \quad L_{W, max} = 96.8 \text{ dB(A)}$$

Garage roller gates corresponding to the state of the noise reduction art are quiet in such a way that they need not be taken into account (cf. sect. 6.3.2.1).

7.3 Multi-Storey Car Parks

In the following a calculation method for the sound engineering forecast of multi-storey car parks is developed which takes into account the specifications of the TA Lärm [2] and which shall be as manageable as possible. Based on the results of sound level measurements near multi-storey car parks, described in sect. 6.4, the calculation method's practical suitability is checked.

The suggested calculation method is explained in sect. 8.4 in particular. In the following an overview of the single steps of the calculation method is given and supplementary details are described.

Calculation steps of the calculation method:

- Calculation step 1:
Determination of the sound power level of the parking and passaging traffic's areas per parking floor (cf. section 8.2),
- Calculation step 2:
Determination of the interior noise level per parking floor according to the guideline VDI 2571 [18].
In the second calculation step the influence of the multi-storey car park's limiting planes is taken into account arithmetically. Due to the sound reflections on the ceiling, on the floor and on the walls in the multi-storey car park, the sound level of one parking motion in the multi-storey car park as a rule is increased compared with the comparable situation out of doors. Among others, this level difference is dependent on the room geometry and on the absorption properties of the limiting

For the determination of the interior noise level, if necessary, available sound absorbers can be taken into account (see calculation step 2).

planes. In the suggested approximation method (see sect. 8.4), simplifying, it is accepted that there is a diffuse sound field in the multi-storey car park, although, strictly speaking, in the case of a plane space characteristic no diffuse sound distribution can be expected. For a calculation method as simple as possible, we nevertheless suggest this calculation method which as a rule is lying on the "safe side". For more exact calculations, the motor vehicles' sound scattering and the multiple reflections at the limiting planes can be calculated according to the guideline VDI 3760 'Calculating and Measuring the Sound Propagation in Workrooms' [19]; see also [26].

The following is annotated about this topic in sect. A.2.3.3 of the TA Lärm:

"The sound powers emitted by partial areas of the outer shell of a building have to be determined according to the guideline VDI 2571, section 3, as possible in octavo volumes.

The formula given in the guideline for the calculation of the interior sound levels presumes a diffuse sound field in the room and, as a rule, in factory buildings yields too high values, and only for loud acoustic sources lying near outer shell elements it yields a little too low values. If more exact calculation bases, e.g. according to VDI 3760, version February 1996, are available, the interior sound levels calculated with this can be used."

- Calculation step 3:

Determination of the emitted sound power levels according to the guideline VDI 2571.

In the third calculation step, based on the interior noise level and on the size of the sound radiating areas resp. components and on their acoustic attenuation indices, the sound power levels of the outer components are determined according to the guideline VDI 2571. For a calculation method as simple as possible, in section 8.4 the calculations as a rule take A-weighted summarized levels as a basis.

If spectral calculations are required, the octavo spectrum of the interior noise level can be calculated as follows, based on the (summarized) interior sound level $L_{A\text{feq}}$, determined in calculation step 2, and based on the normalized octavo spectrum given in Tab. 25.

For all relevant areas resp. components, the sound power level emitted per octave is calculated as follows, based on the specifications of the VDI 2571, equation (9 a):

$$L_W = L_1 - R' - 6 + 10 \cdot \log(S/S_0)$$

In accordance with TA Lärm, the emitted sound volumes must be determined in octavo volumes if possible.

Formula 8

with:

L_W sound power level per octave in dB(A),

L_1 interior sound level in dB(A)

R' acoustic attenuation index of the tested component per octave according to VDI 2571, section 3.2, in dB,

S emitting area in m^2

S_0 reference area, $S_0 = 1 m^2$

- Calculation Step 4:

Calculation of the sound propagation in accordance with DIN ISO 9613-2.

In order to check the calculation method, in the following results of sound level measurements near multi-storey car parks are confronted with calculation results taking into account the respective local situation.

In Tab. 32 the sound level's increases of one parking motion in the multi-storey car

park compared with the comparable situation out of doors (see sect. 6.4), determined metrologically near the examined multi-storey car parks, are confronted with calculation results according to the above-mentioned calculation method. As is obvious from Tab. 32, the calculation results agree well with the measurements' results. The approximation method for the determination of the level increases due to the sound reflections on the ceiling, on the floor and on the walls in the multi-storey car park, chosen in the calculation step 2, despite the above-mentioned simplifications (presumption of a diffuse sound distribution) yields realistic results for the cases examined here.

Tab. 32:
Comparison measurement – calculation in the case of an open multi-storey car park

Type of multi-storey car park	Noise level increase during a parking movement in the m.-s. c. p. compared with a parking movement in the open in dB(A)	
	Calculation	Measurement
Open multi-storey car park without sound reducing measures	+ 8.5	+ 9
Open m.-s. c. p. with parking level with a sound absorbing ceiling	+ 3.6	+ 2
M.-s. c. p basement ⁵²⁾ resp. underground car park without sound reducing measures	+ 9.9	+ 9

8 Recommended Calculation Method for the Sound Engineering Forecast

8.1 General Remarks

In this study a method for the calculation of the sound immissions of parking area noise has been developed further, delivering – compared to measurements – results on the safe side as a rule. This calculation method takes into account both the emissions of the traffic searching for carport on the driving lanes and the emissions of the traffic entering and leaving the individual carports, that is the noise of shunting, arriving and leaving and car door's banging.

The sound immissions' rating levels of the operation of private parking areas have to be calculated according to section A.1.4 of the Federal German Noise Regulation – TA Lärm. The connection between the plane-specific sound power level $L_{W''}$ resp. the length-specific sound power level $L_{W'}$ and the sound power level L_W arises from the relations (cf. [13])

$$L_W = L_{W''} + 10 \lg \frac{S}{S_0};$$

with S = partial area and $S_0 = 1 \text{ m}^2$

$$L_W = L_{W'} + 10 \lg \frac{l}{l_0}$$

with l = partial way length and $l_0 = 1 \text{ m}$.

Formula 9

Formula 10

The essential input quantity for the calculation of the sound power level of a parking area is the frequency of motion. In the present inquiry, one vehicle motion is defined as arriving or leaving including shunting, door shutting etc., i.e. one complete parking process with arrival and departure consists of two vehicle motions. In Tab. 33 the results of the vehicle motions' inquiries on different parking areas, performed within the frame of the present investigation, are summarized. The respective value N , indicating the number of vehicle motions per unit B_0 of the reference quantity B per hour, can be read from this table as a clue value. Only for well-founded exceptions it is allowed to deviate down from the clue values. The quantities refer to the respectively given time period of assessment, not to the respective opening hours.

Two clue values are given for the nighttime, and to be more precise the average value of the complete nighttime from 10 p.m. to 6 a.m. and the value of the loudest hour at night. The average values of the day and nighttime can be consulted for the determination of the traffic volume, because according to section 7.4 of the TA Lärm noises of the approaching and leaving traffic on public traffic areas must be calculated and assessed in a distance of up to 500 meters from the parking area resp. from the stationary traffic's area, if need be. According to section 6.4 of TA Lärm, last par., the quantity of the loudest hour at night must be consulted for the calculation and assessment of the nightly sound immissions from the parking area's property.

Since the frequencies of motion, given in chapter 5 per parking area type and inquiry's site, are partly fluctuating strongly, it isn't advisable to calculate with the average values of N , given in the results' tables (Tab. 4 ff.), for sound engineering forecasts. In order to get results "on the safe side", rather the clue values of Tab. 33 should be taken. These, as a rule, represent the maximum values of the inquiries' results per parking area type, whereat in well-founded cases it was deviated from them

The essential input quantity for the calculation of the sound power level of a parking area is the frequency of motion. In the present inquiry, one vehicle motion is defined as arriving or leaving including shunting, door shutting etc., i.e. one complete parking process with arrival and departure consists of two vehicle motions.

In special cases: segmentation of the parking area into partial areas with different frequency of motion.

In order to get results "on the safe side" for areas of the stationary traffic, in the case of sound engineering forecasts the clue values N of the Tab. 33 must be used.

Recommended Calculation

(see also chapter 5). Informations about the assumption of the frequency of motion near hotels with restaurant resp. restaurants can be found in the section 5.8. Accordingly in the case of hotels with a flourishing restaurant, for the determination of the

Tab. 33:
Reference quantities N of the motion frequency near various parking area types for sound engineering forecasts

Parking area type	Unit B ₀ of the reference value B	N = motions/(B ₀ ·h) ^{53) 54)}		
		Day 6a.m.–22 p.m.	Night 22p.m.–6a.m.	Loudest hour at night
P + R area				
P + R area ⁵⁵⁾ , near city, free of charge *)	1 carport	0.30	0.06	0.16
P + R area ⁵⁵⁾ , near city, free of charge **)	1 carport	0.30	0.10	0.50
*) Train station's distance to city centre less than 20 km; **) Train station's distance to city centre more than 20 km				
Filling and recreation station				
<i>Zone filling</i> (no reference value: data in motion per hour)				
Motorcar	-	40	15	30
Lorry	-	10	6	15
<i>Zone recreation</i>				
Motorcar	1 carport	3.50	0.70	1.40
Lorry	1 carport	1.50	0.50	1.20
Residential area				
Underground car park	1 carport	0.15	0.02	0.09
Parking area (overground)	1 carport	0.40	0.05	0.15
Discotheque⁵⁶⁾				
Discotheque	1 m ² net restaurant room	0.02	0.30	0.60
Purchase market⁵⁶⁾				
Small consumer market (net selling area up to 5000 m ²)	1 m ² net selling area	0.10	-	-
Large consumer market resp. dep. store (net selling area more than 5000 m ²)	1 m ² net selling area	0.07	-	-
Discounter ⁵⁷⁾ and beverage market	1 m ² net selling area	0.17	-	-
Electrical supply market	1 m ² net selling area	0.07	-	-
Constr. supply and furniture market	1 m ² net selling area	0.04	-	-
Restaurant⁵⁶⁾				
City restaurant	1 m ² net restaurant room	0.07	0.02	0.09
Restaurant in the rural district	1 m ² net restaurant room	0.12	0.03	0.12
Excursion restaurant	1 m ² net restaurant room	0.10	0.01	0.09
Quick service restaurant (with self service)	1 m ² net restaurant room	0.40	0.15	0.60
Drive-in counter at quick service restaurant (no reference value, but data in motions per hour)				
Drive-In	-	40	6	36
Hotel⁵⁸⁾				
Hotel with less than 100 beds	1 bed	0.11	0.02	0.09
Hotel with more than 100 beds	1 bed	0.07	0.01	0.06
Parking area or multi-storey car park in the city centre, commonly accessible				
Parking area, chargeable ⁵⁹⁾	1 carport	1	0.03	0.16
Multi-storey car park, chargeable	1 carport	0.50	0.01	0.04

The values of the motions per reference quantity and hour refer to the respective time period of assessment, not to the opening hours.

Only for well-founded exceptions it is allowed to deviate down from the clue values of the Tab. 33.

- no movements available

motions per reference quantity and hour the sum of the motions of the dish restaurant's operation and of the overnight stay business must be taken into account. Further informations about the inquiries' results and the used reference quantities can be taken from chapter 5.

It could be observed that chargeable parking areas show considerably lower motion frequencies and occupancies than free of charge parking areas, as long as in the local area parking possibilities free of charge are available. This appearance is particularly valid for chargeable P + R areas and multi-storey car parks. For example, in the case of one P + R area the occupancy declined from full exploitation (during former exemption from charges) to below 50% exploitation (after the installation of charges machines). In this respect the levying of parking fees doesn't promote the changing from the private traffic to the public short-distance traffic. If the recent tendency of levying charges is long-lasting, can't be said yet. It couldn't be quantified yet up to now. Since it is not sure if for always charges will be levied, in the context of the sound engineering forecast the frequencies of motion for free of charge parking areas at ground level, termed in this study, should be taken. Somewhat different is the case of multi-storey car parks being constructed as a rule from the start for the purpose of chargeable parking.

For carports nearby the destination, e.g. at the entrance to the purchase market, the number of motions can be higher than for less attractive carports, being more distant. Sect. 5.10.2 contains exemplary inquiries' results for this. For the sound engineering forecast of larger parking areas therefore it is appropriate to divide up the parking area into separate areas which have to be covered with different frequencies of motion.

In special cases: segmentation of the parking area into partial areas with different frequency of motion.

In the case of the examined dish restaurants and hotels, the following connections between the net restaurant room and the seat number resp. between the number of beds and the number of rooms were determined, whereat these connections aren't provided security for sufficiently:

- 1.2 m² net restaurant room per seat,
- 1.7 beds per room.

In a first-order approximation, however, these conversions can be taken as a basic approach, if, for sound engineering forecasts of dish restaurants and hotels, the reference quantities net restaurant room and number of beds are not available. In the calculation, the clue values termed in Tab. 33 of the motion frequency and the surcharges K_{PA} termed in Tab. 34 for the parking area type as well as K_l for the stroke maximal level method must be taken into account, likewise the maximum levels termed in Tab. 35. Attention must be paid that the surcharge K_l in the case of the separated calculation method is considered only for the determination of the partial rating levels of the entering and leaving of a carport, but not for the determination of the partial rating levels of the traffic on the driving lanes.

Strictly speaking, the surcharge K_l should be made dependent on the distance emission site – immission site, since, with increasing distance from the source, the short-time noise peaks are protruding over the back basic noise less and less, and with that the difference between equivalent level and stroke maximal level becomes smaller and smaller. In order not to make the parking area formula unnecessarily complicated, we neglect this effect and look at the calculation results, thus being too high in a larger distance, as a contribution to a "calculation on the safe side".

In the case of hotels with a flourishing restaurant, for the determination of the vehicle motions per reference quantity and hour the sum of the motions of the dish restaurant's operation and of the overnight stay business must be taken into account.

In special cases: segmentation of the parking area into partial areas with different frequency of motion

The surcharge K_l decreases with increasing distance from the parking area. This effect is neglected regarding the results "on the safe side".

Recommended Calculation

Only for well-founded exceptions it is allowed to deviate down from the clue values of the Tab. 33.

The surcharge K_{PA} for restaurants and quick service restaurants hasn't been investigated explicitly. Since parking areas of restaurants are considerably louder than P + R parking areas, but more quiet than discotheque parking areas, for restaurant parking areas $K_{PA} = 3$ dB(A) and $K_I = 4$ dB(A) can be set. Using this value, additional door shutting and conversation would be taken into account. For quick service restaurants, being visited by young people predominantly, $K_{PA} = 4$ dB(A), i.e. like for discotheques, and $K_I = 4$ dB(A) should be chosen.

A special surcharge for the *approaching traffic zone* to so-called *drive-in counters* is not given. As far as these counters are used preferentially by young people, there the so-called rolling-disco-effect can occur, that is to say if the approaching is performed with open car windows and car radios adjusted to full volume at the same time. This behavior oriented noises were not found near the two tested drive-in counters. In the individual case, the sound engineering expert has to make separate considerations.

With regard to the immission reference values for single short-time noise peaks, given in the TA Lärm, the maximum sound levels appearing during the parking processes were determined in a distance of 7.5 m.

In Tab. 35 the maximum levels³⁵⁾ of the individual vehicle types are summarized.

The noise limiting values for trucks are subclassified in three power categories (< 75 kW; 75 to 150 kW; ≥ 150 kW). For the purpose of an upper estimate, only the values of the power category ≥ 150 kW were determined and given in Tab. 35.

Information about the so-called rolling-disco-effect near drive-in counters (counters for cars, at quick service restaurants)

Tab. 34:
Surcharges K_{PA} and K_I for the various parking area types

Parking area type	Surcharges in dB(A)	
	K_{PA}	K_I
Motorcar parking areas		
P + R areas, parking areas near residential districts, visitors' and employees' parking areas, parking areas at the fringe of the city centre	0	4
Parking areas near shopping centres		
Standard shopping trolleys on asphalt	3	4
Standard shopping trolleys on pavement	5	4
Parking areas near shopping centres		
Low-noise shopping trolleys on asphalt	3	4
Low-noise shopping trolleys on pavement	3	4
Parking areas near discotheques (with ambient noises of conversations and car radios)	4	4
Restaurants	3	4
Quick service restaurants	4	4
Central bus stops		
Busses with Diesel engine	10	4
Busses with natural gas impulse	7	3
Parking spaces resp. car centers for lorries ⁶⁰⁾	14	3
Motorcycle parking areas	3	4

	Accelerated departure resp. driving past	Door shutting	Car tailgate's resp. boot's closing noises ⁶¹⁾	Compressed air noise
Motorcar	67 ⁶²⁾ (Measurement 1984)	72 (Measurement 1999)	74 (Measurement 1999)	-
Motorcycle	73 (Measurement 1999)	-	-	-
Bus	78 (Measurement 1999)	71 (Measurement 1986)	-	77 (Measurement 1986)
Lorry	79 (Measurement 2005)	73 (Measurement 2005)	-	78 (Measurement 2005)

Tab. 35:
Average maximum levels ³⁵⁾ in a distance of 7.5 m in dB(A)

8.2 Parking Areas at Ground Level

8.2.1 Normal Case (So-called Integrated Method)

With this simplified calculation method, in the normal case, rating levels for all sound immission sites influenced by parking area noise can be calculated "on the safe side". Further explanations see in section 7.1.2. The following empirical formula for the determination of the plane-specific sound power level $L_{W''}$ of the parking area with consideration of the driving traffic on the parking area can normally be consulted for the calculation of a parking area's source level, i.e. then if the traffic volume cannot be forecasted sufficiently reliably for the individual driving lanes:

$$L_{W''} = L_{W0} + K_{PA} + K_I + K_D + K_{STRO} + 10 \cdot \lg(B \cdot N) - 10 \cdot \lg(S/1m^2) \text{ in dB(A)}$$

Formula 11a

$L_{W''}$ = plane-specific sound power level of all processes on the parking area (including passing traffic share);

L_{W0} = 63 dB(A) = initial sound power level for one motion/h on a P + R parking area (according to Tab. 30, cf. section 7.1.5);

K_{PA} = surcharge for the parking area type (according to Tab. 34, cf. also section 7.1.5);

K_I = surcharge for the impulse character (according to Tab. 34, cf. also section 7.1.4, valid only for the integrated calculation method);

K_D = $2.5 \cdot \lg(f \cdot B - 9)$ dB(A); $f \cdot B > 10$ carports; $K_D = 0$ for $f \cdot B \leq 10$

Formula 3

K_D = level increase due to the passing traffic and the traffic searching for carport [dB(A)];

f = carports per unit of the reference value;

f = 0.50 carports/m² net restaurant room in the case of discotheques,

= 0.25 carports/m² net restaurant room in the case of restaurants,

= 0.07 carports/m² net selling area in the case of consumer markets and department stores,

= 0.11 carports/m² net selling area in the case of discounting markets,

= 0.04 carports/m² net selling area in the case of shops for electrical supply,

= 0.03 carports/m² net selling area in the case of markets specialized for construction supplies and furniture,

= 0.50 carports/bed in the case of hotels

= 1.0 in the case of other parking areas (P + R areas, employees' parking areas and the like)

In the case of bus stops and of parking areas with less than 10 carports, K_D is cancelled. Also in the case of parking areas with more than 150 carports, the value of K_D is not lying too much on the safe side, so that in the case of large parking areas a seg-

mentation into smaller partial areas is necessary only if the motions per reference value and hour are differing on them. A segmentation into partial areas, under consideration of the point acoustic source criterion (diagonal of the partial area $\leq 0.5 \cdot$ distance between immission site and middle of the partial area), is done automatically by the sound engineering calculation program, on the other hand.

K_{StrO} = surcharge for different lane surfaces:

- 0 dB(A) for asphalt driving lanes;
for other surfaces:
- 0.5 dB(A) for concrete block pavement with joints ≤ 3 mm,
- 1.0 dB(A) for concrete block pavement with joints > 3 mm,
- 2.5 dB(A) for water bound surfaces (gravel),
- 3.0 dB(A) for natural stone pavement.

The surcharge K_{StrO} is cancelled in the case of parking areas near purchase markets with asphalt surface or with a surface paved with concrete blocks, since the level increase due to clattering shopping trolleys is dominating the level and is already taken into account in the surcharge K_{PA} for the parking area type.

- B = reference quantity (number of the carports, net selling area in m^2 , net restaurant room in m^2 or number of the beds).
In the case of several parking areas separated spacially and belonging to one certain reference quantity, e.g. net restaurant room of a consumer market, for the sound power level's calculation the reference quantity must be partitioned proportionally to the separate parking area zones⁶³);
- N = frequency of motion (motions per unit of the reference quantity and hour). If for N no exact censuses are available, useful assumptions have to be made. Clue values for N are arranged in Tab. 33⁶³);
- B · N = all vehicle motions per hour on the parking area surface;
- S = total area resp. partial area of the parking area.

Annex 2 contains an example of the sound engineering calculation according to the integrated calculation method.

8.2.2 Special Case (So-called Separated Method)

In the special case where the traffic volume on the driving lane resp. on the driving lanes can be estimated exactly to some extent resp. proportionally to the area, e.g. near parking areas like blind alleys, for the respective immission site partial rating levels can be calculated from the traffic entering and leaving a carport on the one hand and from the traffic searching for carports and from the passaging traffic on the other hand separately and summarized to the complete rating level. Using this calculation method, one gets lower up to on-level rating levels than using the integrated method, whereat immission sites lying near the parking area's entrance are louder than those lying more away from the entrance. Further explanations see in the sections 7.1.2 and 7.1.3.

8.2.2.1 Partial Emissions of Entering and Leaving a Carport without Passaging Traffic

The plane-specific sound power level of the entering and leaving of a carport is calculated according to the following formula:

$$L_{W''} = L_{W0} + K_{PA} + K_I + 10 \cdot \lg(B \cdot N) - 10 \cdot \lg(S/1\text{m}^2) \text{ in dB(A)}$$

Formula 11 b

It conforms to the formula (11a) given in section 8.2.1, however without the terms K_D and K_{StrO} . K_{PA} and K_I can be taken from Tab. 34.

8.2.2.2 Partial Emissions of Traffic Searching for a Carport and of Passaging-Through-Traffic

The sound emission $L_{m,E}$ of the traffic searching for a carport resp. of the passaging-through-traffic is determined according to RLS-90, whereat instead of D_{StrO} in formula (6) of the RLS-90 [5] the following values K_{StrO}^* must be taken for the determination of the sound emissions of parking areas:

K_{StrO}^* only for the partial rating levels "driving lanes" in the separated calculation method (special case):

- 0 dB(A) for asphalt driving lanes,
- 1.0 dB(A) for concrete block pavement with joints ≤ 3 mm,
- 1.5 dB(A) for concrete block pavement with joints > 3 mm,
- 4.0 dB(A) for water bound surfaces (gravel),
- 5.0 dB(A) for natural stone pavement.

8.3 Underground Car Parks

For the making of a sound engineering forecast for underground car parks it is useful to differentiate the complete situation into the following partial processes:

"closed" underground car park (ramp enclosed):

- Approaching and leaving traffic outside the underground car park ramp,
- sound emission through open garage gate during arriving and leaving traffic,
- potentially further sound sources (passing over a rain gutter, noises when opening a garage roller gate etc.);

"open" underground car park (ramp not enclosed) ⁶⁴:

- Approaching and leaving traffic outside the underground car park ramp,
- traffic on the ramp,
- potentially further sound sources (passing over a rain gutter, noises when opening a garage roller gate etc.).

In sect. 7.2, for special partial processes relevant in a sound engineering way calculation methods were suggested which were developed resp. checked by means of measurements` results.

For the judgement of the sound engineering situation, it is necessary in accordance with TA Lärm [2], apart from the consideration of equivalent levels, also to determine the maximum sound levels in the case of short-time noise peaks.

The sound power levels listed in the following represent the highest values respectively of the approaching resp. leaving traffic; for a differentiated analysis of the approaching and leaving traffic, the values listed in sect. 7.2 can be consulted.

The following partial processes must be taken into account in sound engineering forecasts for underground car parks as a rule:

8.3.1 Approaching and Leaving Traffic, Traffic on not Enclosed Ramps

For a calculation method on the "safe" side, the length-specific sound power level of the approaching and leaving traffic as well as of the traffic on not enclosed ramps is determined by means of the sound emission level $L_{m,E}$ according to the RLS 90 in accordance with the following connection:

Formula 4

$$L_{W', 1h} = L_{m,E} + 19 \text{ dB(A)}$$

For the calculation of the source level $L_{m,E}$ according to RLS 90, a speed of 30 km/h is taken. The authoritative traffic volume M in motor vehicles/h, the inclination of the underground car park ramp and possible corrections for different road surfaces have to be set for the calculation of the source level $L_{m,E}$ in accordance with the specifications of RLS 90 [5].

If necessary, also emissions of motorcycles must be taken into account. In this case particularly short-time noise peaks during the accelerated departure of motorcycles can be of importance. In Tab. 35 maximum levels measured in a distance of 7.5 m are indicated which can be taken as a basis for an assessment. For a forecast calculation on the sure side, the motorcycle share can be taken into account like a truck share according to RLS 90.

The sound power levels of the approaching and leaving traffic in front of the underground car park ramp must be calculated separately from the approaching and leaving traffic in the ramp zone.

The sound propagation is calculated in accordance with TA Lärm [2] according to the norm DIN ISO 9613-2 [9].

The approaching and leaving traffic's noise character is classified as not containing impulse, if no "obstacles" like rain gutters or similar facts contribute to this. Calculation suggestions for these additional sound sources are given in sect. 8.3.3 and 8.3.4.

For a consideration of short-time noise peaks of the approaching and leaving traffic, the following sound power levels can be taken as a basis for point acoustic sources:

"open" ramp, ramp zone:

$$L_{W, \max} = 94 \text{ dB(A)}$$

"closed" ramp, in front of garage gate:

$$L_{W, \max} = 88 \text{ dB(A)}$$

8.3.2 Sound Emission through Open Garage Gate, of Entering and Leaving Traffic, in Case of Enclosed Underground Car Park Ramp

The following plane-specific sound power levels take into account the sound radiation through the open garage gate, whereat the sound emission's directivity characteristics must be regarded (opposite to the vertical direction, lateral to the garage gate (90° to the vertical direction) sound levels lower by about 8 dB(A) are found):

$$L_{W'', 1h} = 50 \text{ dB(A)} + 10 \lg B \cdot N;$$

$$dL(90^\circ) = - 8 \text{ dB(A)} ;$$

$$B \cdot N = \text{number of vehicle motions per hour}$$

Formula 12

The above-mentioned sound power levels were determined by means of sound level measurements (see sect. 6.3.2 and 7.2.3). If the conditions near the underground car park ramp, which shall be examined, are deviating from the situation near the ramps investigated metrologically, an arithmetical method can be used which will deliver results on the "safe" side (see sect. 7.2.3). In the case of a sound absorbing style of the interior walls of the enclosed underground car park ramps, the value of the plane-specific sound power level of formula (12) can be decreased by 2 dB(A).

8.3.3 Passing over a Rain Gutter

If the rain gutter's covering is made in a low noise form, e.g. with screwed cast iron sheets, it is not acoustically striking and therefore has not to be taken into account either.

In the case of coverings which do not comply with the state of the noise reduction art, the noise character when passing over a rain gutter must be rated as containing impulse. In this case the following sound power levels for point acoustic sources can be taken when passing over a rain gutter in addition to the equivalent level of the approaching and leaving traffic:

"open" ramp

(rain gutter below the ramp):

$$L_{W_{\text{Teq}}, 1h} = 72 \text{ dB(A)} + 10 \cdot \lg B \cdot N$$

Formula 13

"closed" ramp

(rain gutter above the ramp):

$$L_{W_{\text{Teq}}, 1h} = 63 \text{ dB(A)} + 10 \cdot \lg B \cdot N$$

Formula 14

$B \cdot N = \text{number of vehicle motions per hour}$

For a consideration of short-time noise peaks when passing over a rain gutter, whose covering does not comply with the state of the noise reduction art, the following sound power level for point acoustic sources can be taken as a basis:

$$L_{W, \text{max}} = 101 \text{ dB(A)}$$

8.3.4 Opening or Closing a Garage Roller Gate

Garage roller gates corresponding to the state of the noise reduction art are not taken into account in sound engineering calculations.

In the case of the garage gates not corresponding to the state of the noise reduction art, the following sound power levels for point acoustic sources can be taken:

Formula 15

$$L_{W\text{Teq}, 1\text{h}} = 69 \text{ dB(A)} + 10 \cdot \lg(2 \cdot B \cdot N)$$

$B \cdot N$ = number of the garage gate's opening resp. closing processes per hour (as a rule two processes per vehicle motion),

for short-time noise peaks:

$$L_{W, \text{max}} = 97 \text{ dB(A)}$$

Annex 3 contains an example of the sound engineering calculation of entering an underground car park.

8.4 Multi-Storey Car Parks

For the construction of a sound engineering forecast for multi-storey car parks, it is useful to subdivide the sound engineering calculations into the following calculation steps:

Calculation step 1:

Determination of the sound power level of the parking and passaging expenses per parking storey according to the calculation method described in the section 8.2.1

Calculation step 2:

Determination of the interior sound level per parking storey according to the guideline VDI 2571

Calculation step 3:

Determination of the emitted sound power levels according to the guideline VDI 2571

Calculation step 4:

Calculation of the sound propagation in accordance with DIN ISO 9613-2

8.4.1 Sound Power Level Determination of the Parking and Passaging-Through Expenses per Parking Storey

In a first calculation step, the plane-specific sound power level per parking storey is determined by means of the integrated calculation method (see sect. 8.2.1). For this calculation step the following input quantities are required per parking storey:

- Number of the carports,
- motion frequency (number of motions per reference quantity and hour),
- parking area type that must be taken.

The parking area type "P + R area" as a rule is taken as a basis for the calculations; if in the multi-storey car park shopping trolleys and corresponding loading activities can be expected, the parking area type "parking areas near purchase markets" can be taken into account.

8.4.2 Determination of the Indoor Sound Level per Parking Storey

In a second calculation step the influence of the multi-storey car park's limiting planes is taken into account arithmetically. Due to the sound reflections on the ceiling, on the floor and on the walls in the multi-storey car park, the noise level during one parking motion in the multi-storey car park increases as a rule, compared with the comparable situation out of doors. This level difference is, among others, dependent on the room geometry and on the absorption properties of the limiting planes.

By means of the approximation formula (6) of the guideline VDI 2571 "Sound Radiation of Industrial Buildings" [18] the indoor sound level per parking storey can be determined as follows, taking the sound power level of the parking and passing-through expanses, the room geometry and the absorption properties of the limiting planes as a basis:

$$L_I \approx L_W + 14 + 10 \log (T/V) = L_W + 14 + 10 \log (0.16/A) \quad \text{Formular 16}$$

with:

L_I = indoor sound level in dB(A)
 L_W = sound power level in dB(A)

$$L_W = L_{W''} + 10 \log(S/S_o)$$

Formular 9

with:

S = radiating area (parking and passing-through expanses) in m^2
 S_o = reference area, $S_o = 1 m^2$
 $L_{W''}$ = plane-specific sound power level, result of calculation step 1

T = reverberation time in seconds; $T = 0.16 V / A$

V = room volume in m^3

A = equivalent absorption area in m^2

$$\text{with: } A = \alpha_1 \cdot A_1 + \alpha_2 \cdot A_2 + \dots + \alpha_n \cdot A_n$$

Formular 17

α_i = absorption coefficients of the limiting planes

A_i = partial areas of the limiting planes in m^2

Remark: the absorption coefficient of concrete e.g. is approx. $\alpha_{\text{Beton}} \approx 0,03$

For the determination of the indoor sound level, if necessary, available sound absorbers can be taken into account.

In this method, simplifying, it is accepted that there is a diffuse sound field in the multi-storey car park, although, strictly speaking, in the case of a plane space characteristic no diffuse sound distribution can be expected. For a calculation method as simple as possible, we nevertheless suggest this calculation method which as a rule is lying on the "safe side". For more exact calculations, the motor vehicles' sound

scattering and the multiple reflections at the limiting planes can be calculated according to the guideline VDI 3760 'Calculating and Measuring the Sound Propagation in Workrooms' [19]; see also [26].

8.4.3 Determination of the Radiated Sound Power Levels

In a third calculation step, based on the indoor noise level and on the size of the sound radiating areas resp. components and on their acoustic attenuation indices, the sound power levels of the outer components are determined according to the guideline VDI 2571.

For a calculation method as simple as possible, the calculations as a rule take A-weighted summarized levels as a basis. If spectral calculations are required, the informations in sect. 7.3 can be taken into account.

For all relevant areas resp. components, the emitted sound power level is calculated as follows, based on the specifications of the VDI 2571, equation (9b):

Formula 18

$$L_{WA} = L_I - R'_W - 4 + 10 \log(S/S_0)$$

with:

L_{WA} = sound power level in dB(A)

L_I = indoor sound level in dB(A)

R'_W = acoustic attenuation index of the respective component

S = emitting area in m²

S_0 = reference area, $S_0 = 1 \text{ m}^2$

8.4.4 Sound Propagation Calculation

The sound propagation is determined in accordance with TA Lärm according to the norm DIN ISO 9613-2 [9]. The approaching and departure areas can be calculated with the method for underground car park ramps suggested in sect. 8.3.

Annex 4 contains an example of the sound engineering calculation of a multi-storey car park.

8.4.5 Maximum Noise Levels

The calculation methods described in section 8.2 were verified by means of controlling measurements near the parking area types P + R area, purchase market and discotheque. They are explained in the section 9.1. In the section 9.2 the controlling measurements' results are compared with the results calculated according to section 8.2.2.

9 Comparison of Calculation Results with Controlling Measurements Results

The calculation methods described in section 8.2 were verified by means of controlling measurements near the parking area types P + R area, purchase market and dis-cotheque. They are explained in the section 9.1. In the section 9.2 the controlling measurements' results are compared with the results calculated according to section 8.2.2.

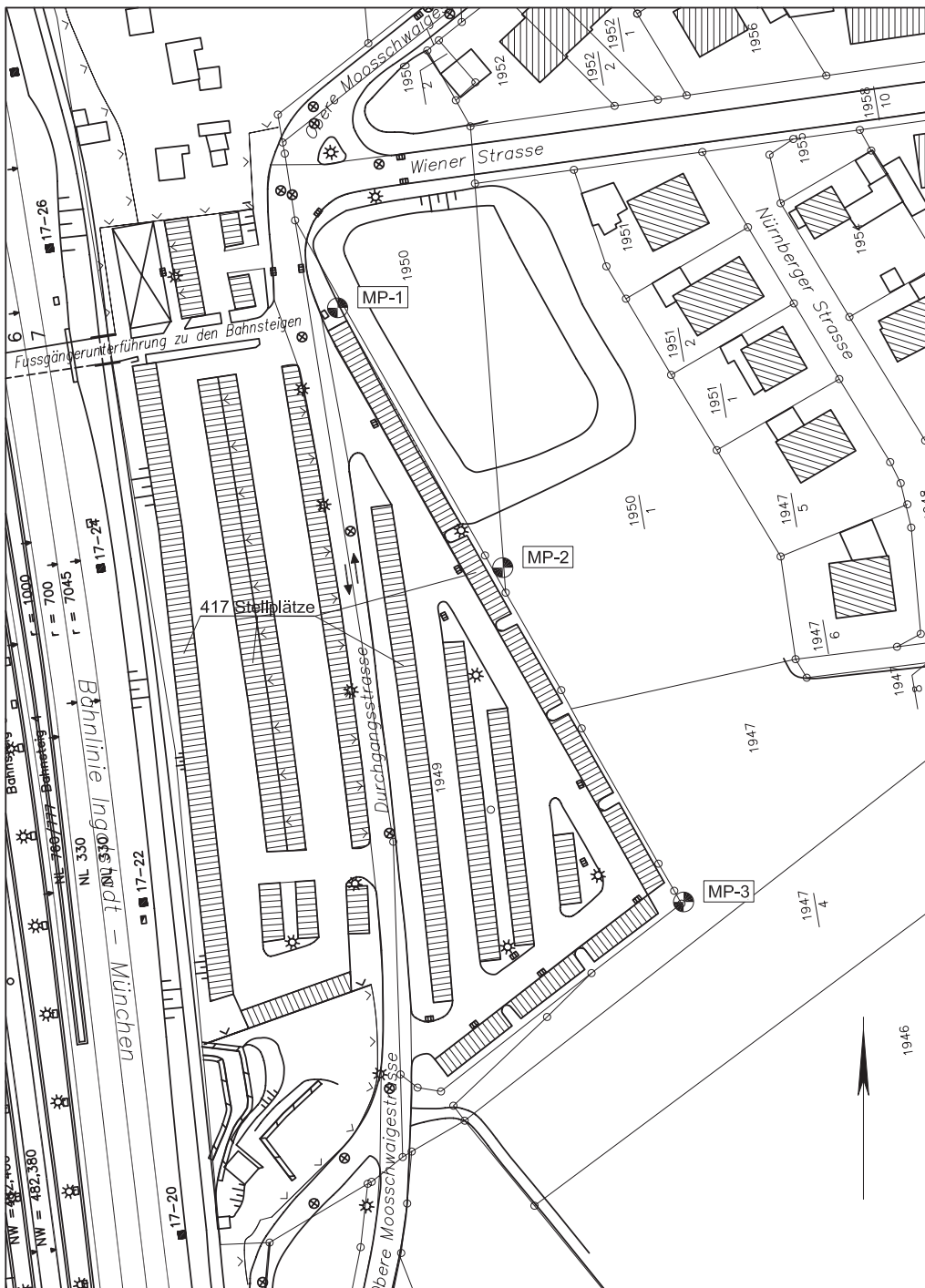


Fig. 32:
 Site plan of the controlling measurements near the P + R area Dachau, measuring points (MP) 4 m above ground (with use of the base data of the Bavarian Measurement Administration; reproduction of the cadastral map no. NW VI.5.15 M = 1: 1000 by approval of the Bavarian Land Surveying Office München Nr. 1442/03)



Fig. 33:
 Site plan of the controlling measurements near a purchase market, measuring points (MP) 3 m above ground (with use of the base data of the Bavarian Measurement Administration; reproduction of the cadastral map M = 1: 1000 by approval of the Bavarian Land Surveying Office München Nr. 1442/03)

9.1 Controlling Measurements

The sound level measurements were performed during a period of approx. 3 hours respectively, in which the measuring time periods per probe site were fixed to the vehicle motion density to be expected at most. The position of the microphones was chosen in the way that on the one hand the sum of the noises emitted from the parking area (parking processes, passing-through traffic, partly shopping trolleys, partly conversations of discotheque visitors) could be recorded metrologically and on the other hand the influence of further strange noises could be kept small. Parallel to the sound level measurements, the number of the vehicle motions was recorded.

For the measuring conditions' illustration, the site plans of the sound level measurements are shown in fig. 32, 33 and 34, with detail of the measuring points' position⁶⁵).

In fig. 35 and 36 exemplary level-to-time diagrams of the controlling measurements are given showing the temporal course of the sound pressure level and of the stroke maximal level. The stroke maximal level is taken into account in accordance with TA Lärm for noises containing impulse, the surcharge K_I for containing impulse being defined as difference of the equivalent level with and without consideration of the stroke maximal level method ([2], sect. A.3.3.6).

In the evaluations, the time periods with relevant strange noises (e.g. train passing traffic near the P + R area), appearing during the measurements, were cancelled.

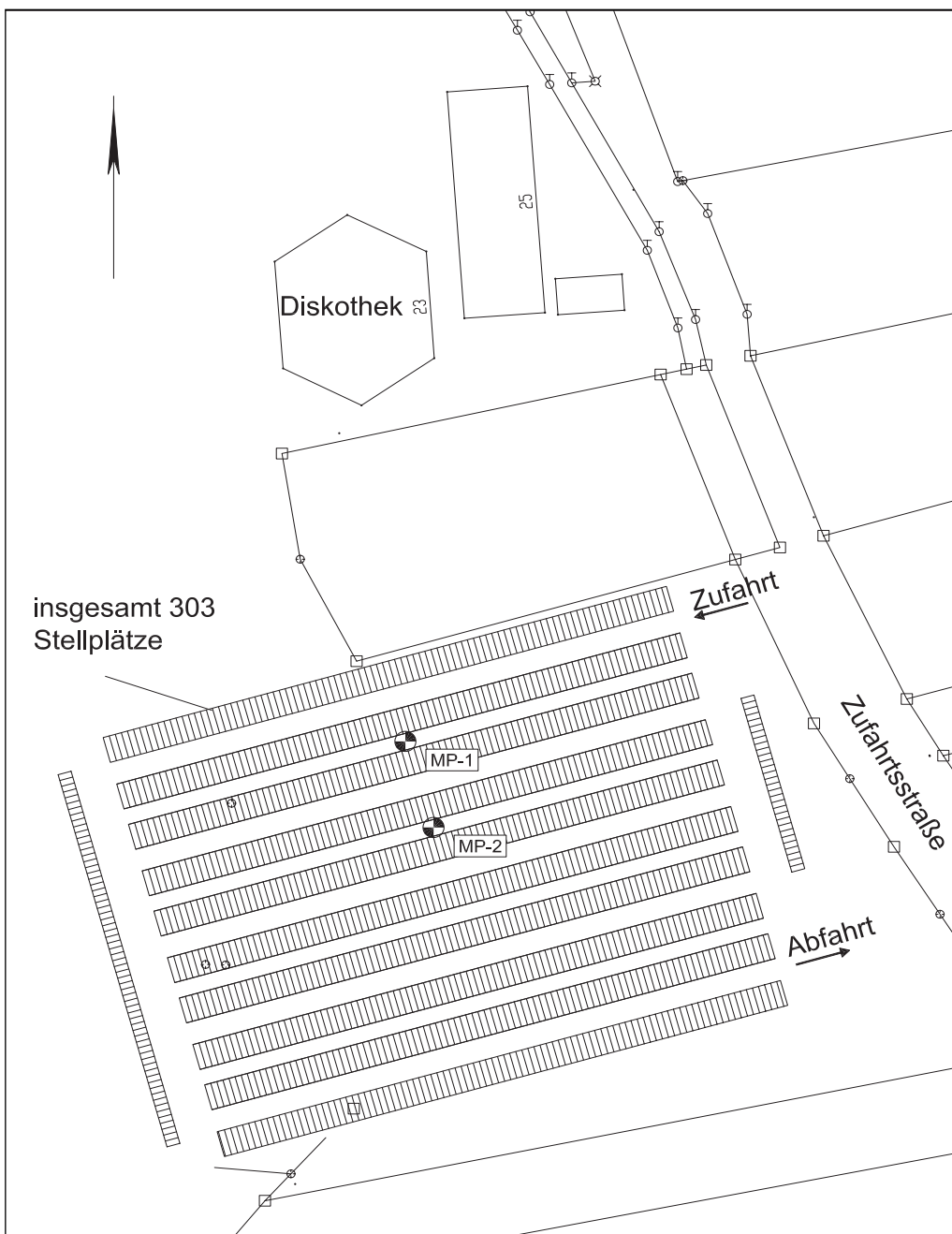


Fig. 34:
Site plan of the controlling measurements near a discotheque, measuring points (MP) 6.5 m above ground (with use of the base data of the Bavarian Measurement Administration; reproduction of the cadastral map M = 1:1000 by approval of the Bavarian Land Surveying Office München Nr. 1442/03)

Fig. 35:
Exemplary level-to-time
diagram, controlling
measurements

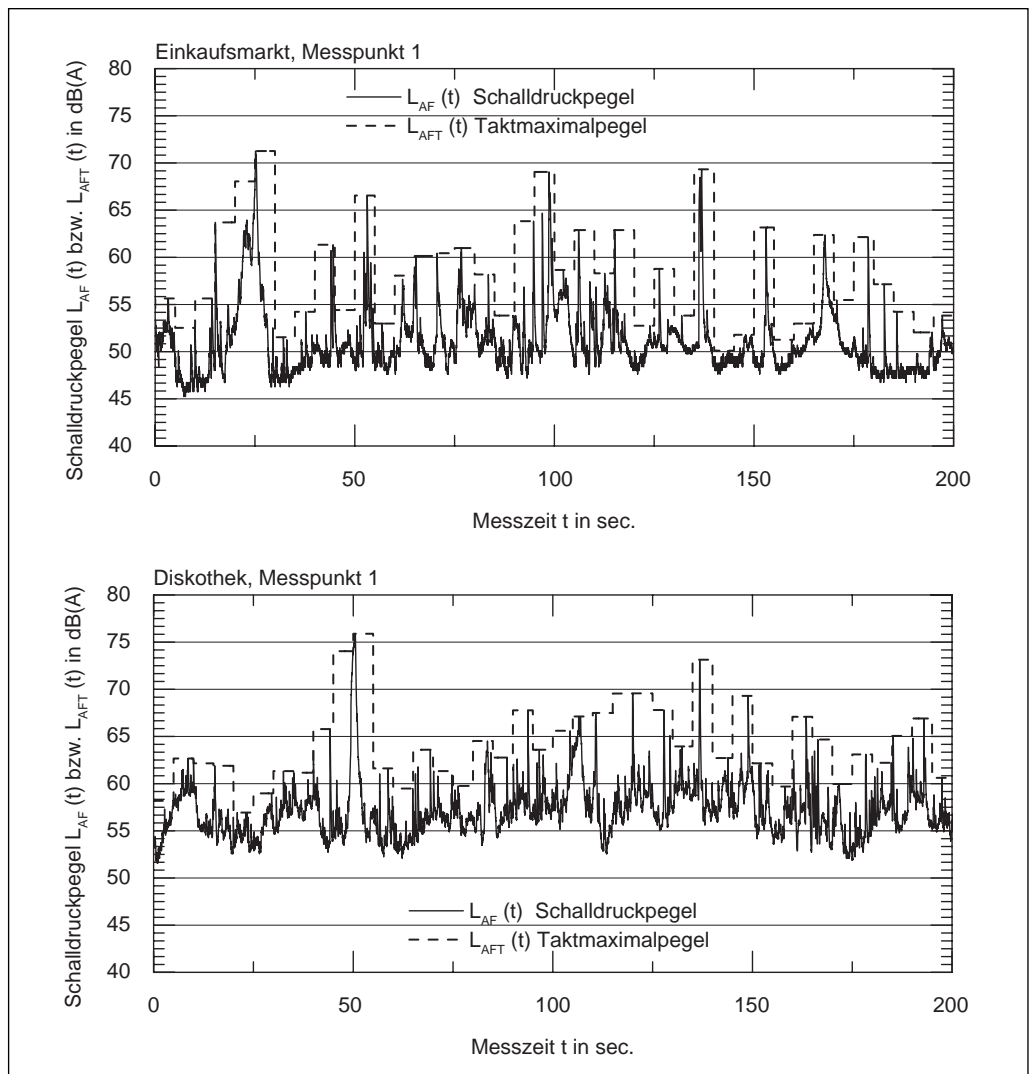
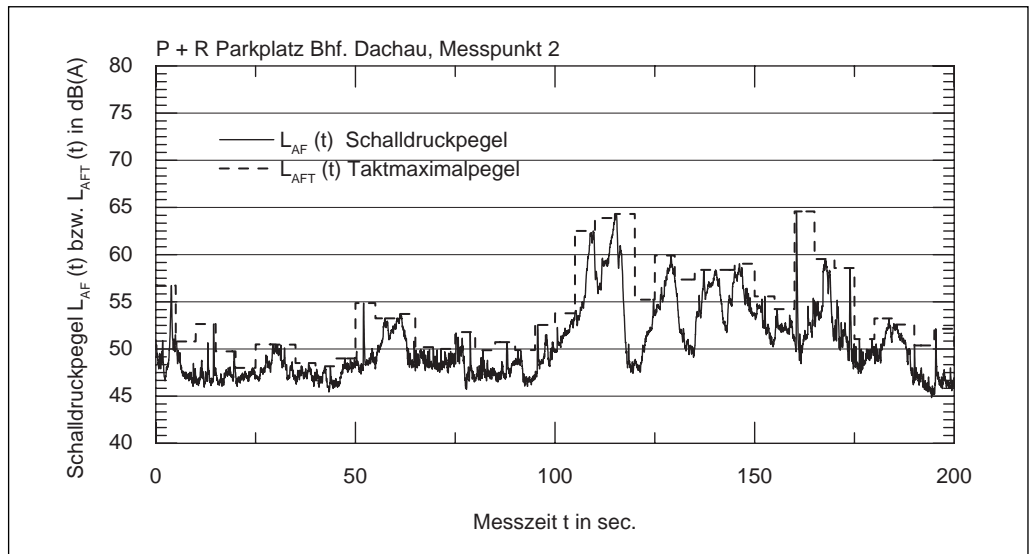


Fig. 36:
Exemplary level-to-time
diagrams, controlling
measurements

9.2 Comparison of the Rating Level Measurements with the Calculations

In Tab. 36 the controlling measurements' results near the parking area types purchase market, discotheque and P+R area are compared with calculation results according to the "separated" calculation method (cf. sect.8.2.2). The calculation according to the "integrated" calculation method (cf. sect. 8.2.1) yields clearly higher results in comparison with the measurement.

The surcharge K_I for containing impulse, determined in the controlling measurements near the purchase market in the amount of 8.3 dB(A) to 8.5 dB(A), is lying somewhat above the value in an amount of 8 dB(A) suggested in sect. 8.2.2.1, but within the range of the metering precision. In addition, the distances for the determination of K_I were different during the controlling measurements and during the measurements described in the sect. 6.1.1 (cf. also Tab. 18, Tab. 28 a³⁴): During the controlling measurements at the purchase market the measuring point was situated in a distance of 5 resp. 8 m, during the measurements, described in the section 6.1.1, for the determination of the sound power levels it was situated in a distance of 19 m.

Inquiry probe site	Sound levels determined near the measuring points For measuring points' position: see site plans					Comparing calculation according to the separated calculation method	
	Meas. time [sec.]	L _{AFmax} [dB(A)]	L _{AFeq} [dB(A)]	L _{AFTeq} [dB(A)]	K _{I, meas.} [dB(A)]	L _{AFTeq} [dB(A)]	K _I * [dB(A)]
Purchase market in the district München, rural area (44 carports)							
Measuring point 1	4780	81.4	51.9	60.2	8.3	60.7	8
Measuring point 2	5280	73.0	50.9	59.4	8.5	61.7	8
Discotheque in a small town in the district Aichach-Friedberg (303 carports)							
Measuring point 1	5295	75.9	55.7	61.0	5.3	62.9	8
Measuring point 2	5250	75.6	56.1	61.8	5.7	63.4	8
P + R area Dachau (417 carports)							
Measuring point 1	2320	71.4	54.2	58.8	4.6	60.3	8
Measuring point 2	2320	72.2	52.7	57.5	4.8	57.2	8
Measuring point 3	2320	64.5	49.4	52.0	2.6	53.3	8

Tab. 36: Controlling measurements' results in comparison with calculation results

10 Sound Engineering Assessment of Parking Areas and Other Facilities of the Stationary Traffic in Germany

The statements in chapter 10 exclusively deal with the statutory and administrative rules within the realm of the Federal Republic of Germany. They are of no importance for the audiences addressed by the english version of the parking area noise study and therefore are not printed here.

11 Recommendations for Planning in View of Sound Protection

Editing: Bavarian State Agency for the Environment

11.1 General Remarks

Main cause for many noise problems is the fact that the matter "noise protection" during the planning of building projects in many cases is treated only at the end. As a rule, the sound engineering adviser then can only try "to prevent the worst", since fundamental planning changes frequently are connected with costs and delays. Also in the case of facilities of the stationary traffic, the technical planning for traffic and building on the one hand and the optimization of the sound protection engineering on the other hand are joined together narrowly. Therefore sound engineering considerations and inquiries should have influence on the planning from the beginning.

We now don't want to expand on the determination of the carport requirement in dependence of the building resp. area usage as well as on the planning concerning traffic engineering. Concerning this, it is rather referred to the corresponding guidelines, e.g. [11], [33]ff. ff. In the following, these shall be supplemented in view of the noise protection.

In order to estimate the motion frequencies on a planned parking area, in Tab. 33 clue values for the more frequent types of parking areas are termed. They represent the highest counted values found out during the examinations. A forecast calculation within the framework of a sound engineering examination will as a rule be lying on the safe side with these values. Therefore they should be used in the calculation if no more exact counting results are available. Also in the case of shopping centers, the values are related to the indicated time period of assessment, not to the store opening hours.

In the case of parking area types not mentioned in Tab. 33, assumptions seeming to be useful have to be taken. So e.g. company parking areas will show motion rates similar to P + R areas. If the building owner is oversizing parking areas wittingly e.g. near a shopping center in order to be prepared for the peak demand, this can be taken into account by dividing the parking area into partial areas with different motion frequencies.

Frequently near parking areas "single short-time noise peaks" (L_{AFmax} , cf. no. 6.1 of the TA Lärm) are critical and are also the cause of complaints. Single short-time noise peaks, e.g. by door shutting, according to section 6.1 of the TA Lärm must not exceed the immission reference values during the day by more than 30 dB(A) and at night by more than 20 dB(A) (so-called maximum level criterion). The horizontal minimum distances between the immission site and the border of the parking area, accordingly required at the closest carport, are – in the case of a free sound propagation – obvious from Tab. 37 for the nighttime period, depending on the carport usage and on the kind of the adjacent specific land-use areas. At compliance with these distances, for the respective area type the immission reference values at night are exceeded by no more than 20 dB(A).

The horizontal minimum distances between the critical immission site and the closest carport, termed in Tab. 37 under consideration of the nighttime maximum level criterion, were calculated according to DIN ISO 9613-2, taking the maximum levels from the Tab. 35 and assuming a free sound propagation, an octavo mid frequency

When planning facilities of the stationary traffic, sound engineering considerations must have influence on the planning from the beginning.

Area use according to sect. 6.1 of TA Lärm	Immission reference values in dB(A)	Required distance [m] from the parking area's fringe to the closest immission site in case of carport's use during the night by ...				
		Motorcars (without purch. market)	Motorcars (purch. market)	Motorcycles	Busses	Lorries
Absolute res. area (WR)	35	43	51	47	73	80
General res. area (WA)	40	28	34	32	48	51
Area type: center, village and mixed usage (MI)	45	15	19	17	31	34
Industrial estate (GE)	50	6	9	8	18	20
Industrial area (GI)	70	<1	<1	<1	<1	<1

Tab. 37: Minimum distances between the critical immission site and the closest carport at night

of 500 Hz, an emission site's height of 0.5 m as well as an immission site's height of 5.8 m (1. floor).

As mentioned, according to TA Lärm single short-time noise peaks are not allowed to exceed the daytime immission reference value by more than 30 dB(A). Also for the daytime maximum level criterion, assuming the maximum levels according to Tab. 35 of this study, the horizontal minimum distances between the house-building worthy of protection and the border of the parking area have been calculated. For motorcar and motorcycle carports they are lying in the range of lower than 1 m, for bus and truck parking spaces in the range of 4 m. This shows that the daytime maximum level criterion in the case of parking area noise has to be checked in the practice at all events for parking spaces resp. stops of heavy freight vehicles and busses.

Sound engineering examinations near parking areas with use also at night as a rule are dispensable if the carports closest to the immission site keep these minimum distances. In special cases a sound engineering examination can nevertheless be necessary, e.g. for parking areas with a high motion frequency during the authoritative full night hour.

Sound engineering examinations near parking areas with use also at night as a rule are dispensable if the carports closest to the immission site are keeping the minimum distances termed in Tab. 37.

11.2 The Traffic Surroundings of the Parking Area and the Arrangement of Carports and Entrances

When planning a parking area, not only the parking area space to be planned must be regarded but also the "traffic surroundings". Type, size and structure of a parking area just as the building and land use in the adjacent areas are important magnitudes of influence for the environment-friendly planning of a parking area facility. The, in a sound protection engineering way, unfavorable arrangement of accesses or of certain carport areas is one of the frequent deficiencies.

Special attention has to be directed to the arrangement of the entrances and exits of parking areas, multi-storey car parks and underground car parks. The approach to the facility of the stationary traffic shall come from a busy road on the shortest way and in no case shall lead through side streets which are quiet up to now. Parking areas assigned to stations should be arranged nearby the anyway loud tracks. From the view of the sound protection it can be useful to set several accesses and a one-way control for the driving lanes, for a better guide of the traffic searching for carport.

In the case of facilities of the stationary traffic the, in a sound protection engineering way, unfavorable arrangement of accesses or of certain carport areas is one of the frequent deficiencies.

Long parking areas in the form of a blind alley cause higher emissions in the zone of the only access than rectangular parking areas with several entrances and exits. If larger parking areas, underground car parks or multi-storey car parks are set up newly, the access must be arranged in a sufficient distance to neighboring living buildings.

In the case of too small distances of the carports to the house-building worthy of protection, the maximum level criterion according to TA Lärm [2] can not be complied with any more (cf. sect. 11.1, 5. paragraph).

On parking areas near stations, in the morning, in particular in the outside districts of compact urban areas partly still at night, at first the carports nearby the platform entrances are occupied. Carports nearby the entrance of shopping centers, restaurants etc. are visited more frequently than the remoter ones. These coherences should be taken into account during the sound engineering optimization of the planning.

When arranging parking areas newly, separate areas for different vehicle types should be provided particularly then if you want to achieve that louder vehicle types are parking not immediately next to building and land use with a high expectation concerning the noise protection. In addition, through this the immission shares of the individual vehicle types can be represented separately, what under circumstances can be desired. An example of this are parking areas for lorries on which also trucks with cooling units are parked. Due to the high sound emissions of these aggregates 34), often working for the whole night, e.g. near truck operating centers special carports for trucks with cooling units should be planned which are moved as far away as possible from the living buildings or arranged behind screening buildings or sound protection walls.

11.3 Sound Protection Measures

According to the state of the art (cf. also § 3, para. 6 BImSchG), for parking areas fundamentally all customary sound protection precautions are possible as sound protection measures. In our case, these are particularly rescheduled plannings, moving (primarily of the access), shieldings (e.g. embankments and walls, auxiliary buildings), business time limits (particularly on the areas which are endangered by immissions), stationary encapsulated (instead of mobile) compressors for compressed air and electrical connections for cooling units in the case of truck parking areas. With the sound protection measures listed here mostly simultaneously immission pollutants by air contaminations are reduced.

By embankments and walls particularly the carports near the border of the parking area can be protected. For larger parking areas representing extended plane acoustic sources, however, embankments and walls as a whole aren't mostly causing a sufficient total level reduction.

Access ramps of underground car parks, on which as a rule there is a racy driving in low gears, must be enclosed fundamentally for the sound protection reasons. Through this they become not only considerably quieter but also winter safe. The access ramps, if possible, mustn't be arranged opposite to buildings needing protection (immission sites). If this cannot be avoided, the ramps' enclosure, i.e. the walls and the ceiling, shall be faced on the inside in a highly absorbing manner.

Access ramps of underground car parks must fundamentally be enclosed.

12 Annex

- Annex 1: Abbreviation Index
- Annex 2: Example of the Sound Engineering Calculation of a Parking Area
- Annex 3: Example of the Sound Engineering Calculation of an Underground Car Park Entrance
- Annex 4: Example of the Sound Engineering Calculation of a Multi-Storey Car Park
- Annex 5: Measurement Results of Busses, Partial Processes During Parking Motions
- Annex 6: Measurement Results of Entering and Leaving Motorcars at the Tested Underground Car Park Ramps
- Annex 7: Measurement Results at the Tested Multi-Storey Car Parks During Simulated Parking Processes
- Annex 8: Remarks
- Annex 9: Acts, Regulations, Literature
- Annex 10: Figures` Dictionary

Annex 1: Abbreviation Index

Fig.	Figure
Sect.	Section
AllMBI	Ministry official leaf of the Bavarian State Government (<i>Allgem. Ministerialblatt der Bayer. Staatsregierung</i>)
B	Reference value (number of the car-ports, net selling area, net restaurant room, number of the beds)
B ₀	Unit of the reference value (1 carport, 1 m ² net selling area, 1 m ² net restaurant room, 1 bed)
Bek.	Announcement (<i>Bekanntmachung</i>)
BGBI	Federal law gazette (<i>Bundesgesetzblatt</i>)
BImSchG	Federal Immission Protection Act (<i>Bundes-Immissionsschutzgesetz</i>)
f	carports per unit of the reference value
GE	Industrial estate (<i>Gewerbegebiet</i>)
GI	Industrial area (<i>Industriegebiet</i>)
IP	Immission site (<i>Immissionspunkt</i>)
K _D	Sound share caused by motor vehicles passing through
n.d.	no data
Chap.	Chapter
Kfz	Motor vehicle (<i>Kraftfahrzeug</i>)
K _I	surcharge for the forecast calculation of the stroke maximal level method; it must be taken in the case of the integrated calculation method as well as in the case of the separated calculation method.
K _I *	surcharge for the stroke maximal level method, determined metrologically without consideration of the traffic searching for carport; it must not be taken for the forecast calculation.
K _{PA}	Surcharge for the parking area type
K _{StrO}	Surcharge for different lane surfaces (in the case of the integrated calculation method)
K _{StrO} *	Surcharge for different lane surfaces (only for the partial emission of the driving lanes in the case of the separated calculation method instead of DStrO in formula (6) of the RLS-90 [5])

L_{AFeq}	A-weighted equivalent level, time weighting "Fast"
$L_{AFeq,1h}$	A-weighted equivalent level per hour, time weighting „Fast“
L_{AFmax}	A-weighted maximum level, time weighting "Fast"
L_{AFTeq}	A-weighted equivalent level according to the stroke maximal level method, time weighting "Fast"
$L_{AFTeq,1h}$	A-weighted equivalent level per hour according to the stroke maximal level method, time weighting "Fast"
L_{Weq}	Average sound power level for one parking motion per hour
L_{WTeq}	Average sound power level for one parking motion per hour according to the stroke maximal level method
L_W'	Length-specific sound power level
L_W''	Plane-specific sound power level
L_{W0}	Basic sound power level for one motion per h on a P + R parking area
LfU	Bavarian State Agency for the Environment (<i>Bayer. Landesamt für Umwelt</i>)
Lkw	Heavy freight vehicle (<i>Lastkraftwagen</i>)
MABI	Ministry office leaf of the Bavarian State Ministry of the Interior (<i>Ministerialamtsblatt des Bayer. Staatsministeriums des Innern</i>)
MI	Area of mixed usage (<i>Mischgebiet</i>)
MP	Measuring point (<i>Messpunkt</i>)
N	Vehicle motions per unit of the reference value and hour
Pkw	Motorcar (<i>Personenkraftwagen</i>)
P + R area	Park-and-Ride area (parking area near station)
RLS-90	Guidelines for the Noise Protection at Roads (<i>Richtlinien für den Lärmschutz an den Straßen</i>), edition 1990
S	Area
s.	see
SO	Special area (<i>Sondergebiet</i>)
StVZO	Road Traffic Admittance Order (<i>Straßenverkehrs-Zulassungsordnung</i>)
Tab.	Table
TA Lärm	Federal German Noise Regulation (<i>Technische Anleitung zum Schutz gegen Lärm</i>)
TG	Underground car park (<i>Tiefgarage</i>)
cf.	compare
WA	General residential area (<i>Allgemeines Wohngebiet</i>)
WR	Absolute residential area (<i>Reines Wohngebiet</i>)

Annex 2:

Example of the Sound Engineering Calculation of a Parking Area

The sound immission coming from a company parking area containing 53 carports (site plan Fig. 38) is to be calculated at a residential building. In Tab. 33 no counting results for the motion frequencies on company parking areas are given. Therefore a useful assumption must be taken. Since as a rule the employees of a company, similar to a P + R area, are arriving in the morning with the car and leaving in the evening again, also the motion frequency will be comparable to a P + R area. We therefore set the values N for P + R areas for the calculation of the sound emission. Since the individual processes on the parking area, because of the same average number of the passengers per vehicle, are corresponding to those of a P + R area, for the sur-

charges K_{PA} and K_I the values of P + R areas are adopted, too. The calculation with the calculator program CadnaA Version 3.6.117 is carried out exemplary for the day-time (6 a.m. – 22 p.m.) and for a residential building in the general residential area; in addition, the maximum levels of short-time noise peaks are determined.

As a rule, the calculation particularly of the sound immissions will be carried out with a computer program. If need be, at first the parking area must be divided by hand into partial areas with different motion frequency. On the other hand, the further division of the parking area into partial areas, being so small that they satisfy the point acoustic source criterion, will be carried out by the program automatically.

Since our parking area contains only 53 carports and since the employees as a rule have their reserved carports, we simplifying assume the same motion frequency for all zones of the parking area. As a consequence, the division of the parking area into partial areas can be carried out automatically by the computer, since for the division of the parking area into partial areas only the point acoustic source condition must be taken into account.

In the case of a calculation according to the calculation method described in sect. 8.2.1, the predefinition of the driving movements on the driving lanes is cancelled. As an alternative for this, a surcharge K_D dependent on the number of the carports is taken for the sound power level found out for the actual parking processes.

A 2.1 Calculation of the Sound Emissions

The considered parking area contains altogether 53 carports. The plane-specific sound power level of the parking processes on the company parking area in accordance with formula 11a amounts to:

$$L_W'' = L_{W0} + K_{PA} + K_I + K_D + K_{StrO} + 10 \cdot \lg(B \cdot N) - 10 \cdot \lg(S/1m^2) \text{ [dB(A)]}$$

with:

L_W'' = plane-specific sound power level;

L_{W0} = sound power level of one motion/h on P + R areas = 63 dB(A);

K_{PA} = surcharge for the parking area type, on P + R areas = 0 dB(A) (s. Tab. 34);

K_I = surcharge for the impulse character, on P + R areas = 4 dB(A) (s. Tab. 34);

K_D = surcharge for the traffic passing and searching for carport in the driving lanes
 $= 2.5 \cdot \lg(f \cdot B - 9)$

f = carports / unit of reference value; here: $f = 1$;

K_{StrO} = surcharge for different lane surfaces, in the example 0 dB(A);

B = reference value, in the example = 53;

N = motion frequency, on P + R areas during the day (6 a.m. – 22 p.m.) = 0.30 (s. Tab.33);

S = parking area's size (carports including driving lanes) in m^2 .

For the company parking area in our example therefore the following sound power level L_W of the parking processes results (formula 9):

$$\begin{aligned} L_W &= L_W'' + 10 \cdot \lg(S/1m^2) \text{ [dB(A)]} \\ &= L_{W0} + K_{PA} + K_I + K_D + 10 \cdot \lg(B \cdot N) \text{ [dB(A)]} \\ &= 63 + 0 + 4 + 2.5 \cdot \lg(53 - 9) + 10 \cdot \lg(53 \cdot 0.3) \text{ [dB(A)]} \\ &= 67 + 2.5 \cdot \lg 44 + 10 \cdot \lg 15.9 \text{ [dB(A)]} = 83.1 \text{ dB(A)} \end{aligned}$$

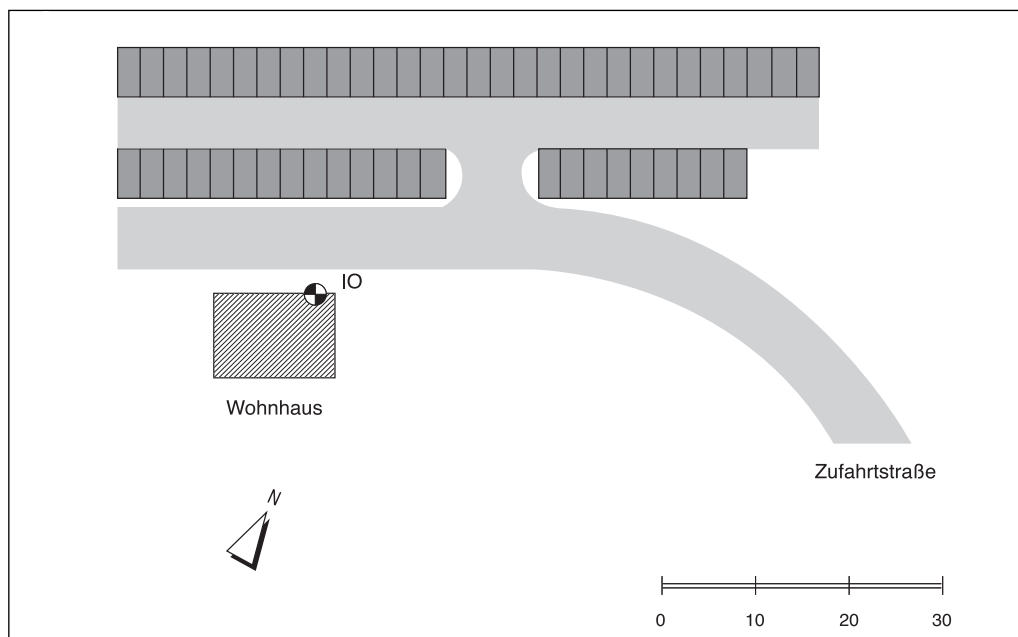


Fig. 38:
Site plan for the calculation example of a company parking area containing 53 carports

A 2.2 Calculation of the Sound Immissions

The sound power level calculated in the sect. A 2.1 for the complete company parking area, used only on workdays, is assumed to be uniform all over the complete parking area expanse in a height of 0.5 m above ground. The calculation of the sound propagation and of the noise immissions at the immission site, lying on the residential building's side turned towards the parking area, is carried out in accordance with the annex of the TA Lärm according to the guideline DIN ISO 9613-2.

Since the residential building is lying as a two-storied building in a general residential area, for the determination of the rating levels for time periods of the day showing an increased sensitivity (in accordance with sect. 6.5 of the TA Lärm, on workdays these are the periods from 6 a.m. to 7 a.m. and from 20 p.m. to 22 p.m.) a surcharge in the amount of 6 dB(A) is given. Related to the altogether 16-hours-time-period of assessment, from this a surcharge in the amount of 1.9 dB(A) arises, assuming that the number of the motions during these hours corresponds approximately with the average value of the hours during the day.

The determination of the rating level L_r due to the only issuer, i.e. due to the complete parking area expanse provided with a surcharge for the longdistance traffic, is performed according to the equations (3) and (4) of the DIN ISO 9613-2 with simplification on A-weighted sum levels as follows:

$$L_r = L_W + D_C - A_{div} - A_{atm} - A_{gr} - A_{bar} - A_{misc} - C_{met}$$

with:

L_W = sound power level of the point acoustic source which characterizes the parking area expanse;

D_C = directivity correction; for sound sources emitting into the half space = 3;

A_{div} = attenuation due to geometric propagation;

A_{atm} = attenuation due to airborne absorption;

A_{gr} = attenuation due to the ground effect;

A_{bar} = attenuation due to shielding by sound obstacles;
 A_{misc} = attenuation due to other effects (vegetation, industrial area, buildings);
 C_{met} = meteorological correction for the description of various weather conditions.

In our example of the company parking area, the meteorological correction just as the attenuation terms, due to shielding and other effects because of the special topographical conditions underlying the example, are yielding no contributions. For the parking area expanse a surcharge for the ground reflection in the amount of 3 dB(A) is following as a directivity correction, since the sound source can emit only into the upper half space. For the rating level's determination, in addition a resulting surcharge for the time periods with an increased interference effect is taken into account.

At the immission site you then get a rating level of 42.0 dB(A) for the first floor and of 41.8 dB(A) for the upper floor, so that the TA Lärm immission reference value of 55 dB(A) for general residential areas is clearly fallen short of.

A 2.3 Calculation of the Maximum Level During Short-Time Noise Peaks

For the calculation of the occurring maximum levels during short-time noise peaks, the closest carport, whose boundary in our example is lying 11 m away from the dwelling house, has to be consulted. Since the banging of the doors, when parking the motorcars, shows the loudest noise peaks (s. Tab. 35), the operative distance between the immission site and the relevant noise source amounts about 13 m. By taking the maximum level, given in Tab. 35 for the door banging, in a distance of 7.5 m as a basis, the maximum sound power level is calculated as follows:

$$L_{W\text{max}} = L_{\text{max}}^{(7,5\text{m})} + 25.5 \text{ dB(A)} = 72 \text{ dB(A)} + 25.5 \text{ dB(A)} = 97.5 \text{ dB(A)}.$$

From this, only under consideration of the attenuation due to the geometric propagation related to the distance of 13 m, the maximum immission level arriving at the immission site can be calculated as follows:

$$L_{r,\text{max}} = L_{W,\text{max}} - A_{\text{div}} + D_C = 97.5 \text{ dB(A)} - 33.3 + 3 \text{ dB(A)} = 67.2 \text{ dB(A)}.$$

Consequently, the daytime immission reference value of 55 dB(A) in general residential areas is exceeded by single noise peaks by 12.2 dB(A), to be sure. But in accordance with sect. 6.1 of the TA Lärm, during the daytime single short-time noise peaks are allowed to exceed the immission reference value by up to 30 dB(A), so that also the maximum level criterion of the TA Lärm is clearly redeemed.

Annex 3: Example of the Sound Engineering Calculation of an Underground Car Park Entrance

In this calculation example, the calculation method suggested in the sect. 8.3 for underground car park ramps is used. With it, the sound immission at two residential buildings, being located in the local area of an, at first open, underground car park entrance, shall be calculated when one immission site is lying in a low distance besides the underground car park and the other one directly opposite the entrance (site plan Fig. 39).

For the calculations the following assumptions are taken as a basis:

- 20 vehicle motions (10 entering and leaving motions each) of motorcars $\leq 2,8$ t per hour.
- The driving speed on the ramp and on the access shall be ≤ 30 km/h.
- Ramp gradient of 13% on a length of approx. 17 m.
- The ramp access is lying on the private property. That means: The horizontal access from the public road to the underground car park ramp is a private street, and the partial rating levels of the traffic on this street must be attributed to the 'noise of facilities, systems and equipment'. If the traffic would lead from the underground car park to a public road, the regulation of the TA Lärm (sect. 7.4, 2. paragraph) would have to be used.
- Ramp and ramp access are paved so that a surcharge for the lane surface according to Tab. 4 of the RLS-90 in an amount of 3 dB(A) for a maximum speed of 30 km/h is set.
- No significant reflections shall occur on the low ramp walls.
- Rain gutter immediately in front of the garage entrance, style of the covering not on the state of the noise reduction art.
- The garage gate produces short-time noises containing impulse character when opening and shutting.

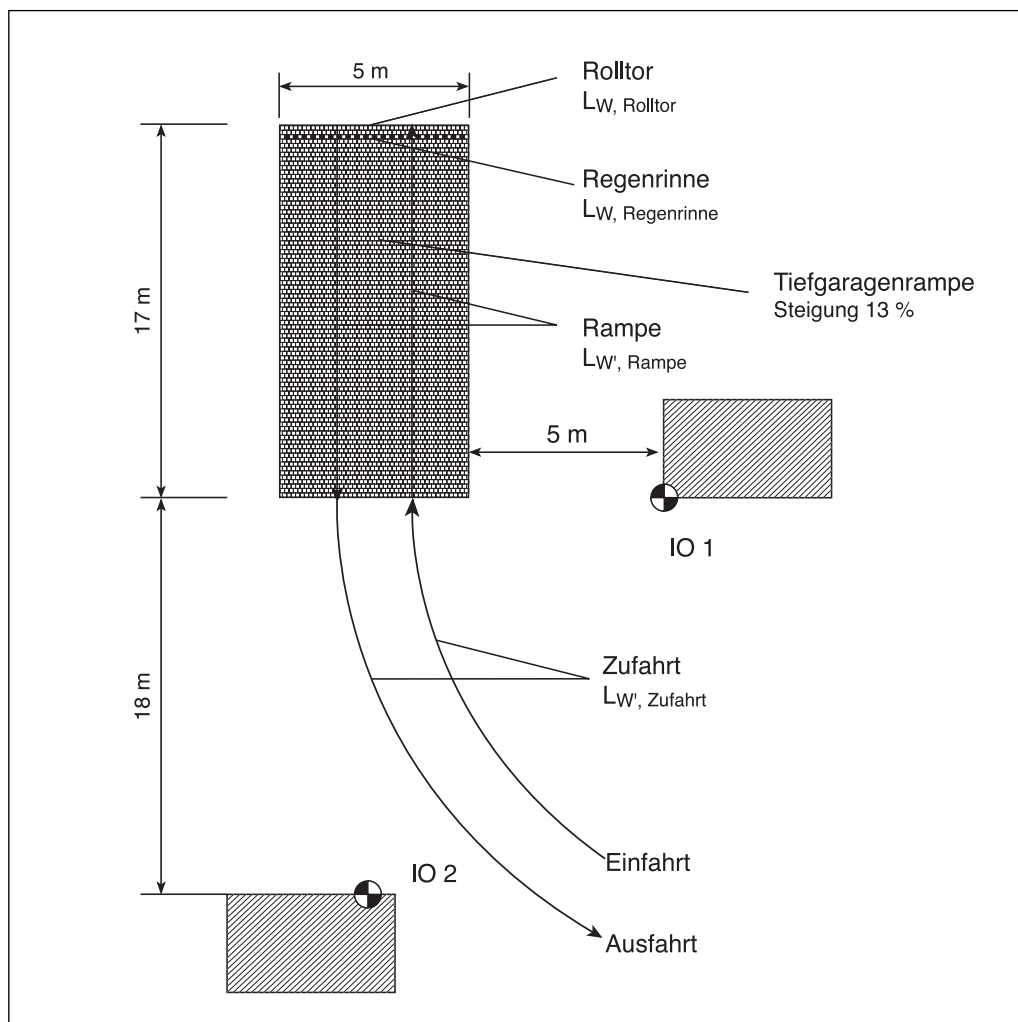


Fig. 39:
Site plan for the calculation example of an open underground car park ramp

Furthermore, in the calculation the residential buildings' location exemplary is assumed to be in a general residential area (immission reference value during the day 55 dB(A), at night 40 dB(A)) as well as the operation of the underground car park is assumed to work only during the day (6 a.m. until 22 p.m.); in addition, the maximum levels during short-time noise peaks are determined.

The calculation particularly of the emission equivalent levels on the driving lanes and of the sound immissions as a rule is carried out by a computer program again, in the example by the program SoundPlan 5.6. For the driveways, thereby the sections on the ramp are distinguished from the sections in front of the ramp.

The sound power levels of the short-time noise peaks, which can arise when passing over the rain gutter as well as when opening and closing the garage gate, are determined according to the basic values termed for this in the sect. 8.3.

A 3.1 Calculation for the Open Ramp

A 3.1.1 Calculation of the Noise Emissions of the Open Ramp

A 3.1.1.1 Traffic on the Ramp

The emission equivalent level for the two driveways (entrance and exit) on the ramp can be calculated in accordance with equation (6) of the RLS-90 as follows:

$$L_{m,E} = L_m^{(25)} + D_v + D_{StrO} + D_{Stg} + D_E$$

[dB(A)]

with:

$L_m^{(25)}$ = equivalent level for a speed of 100 km/h

$$= 37.3 + 10 \cdot \lg(n) \text{ [dB(A)]}$$

$$= 37.3 + 10 \cdot \lg(10) \text{ [dB(A)]} = 47.3 \text{ dB(A)} \text{ (for } n = 10 \text{ Pkw/h);}$$

D_v = correction for the admissible maximum speed, for 30 km/h

$$\Rightarrow D_v = -8.8 \text{ dB(A);}$$

D_{StrO} = correction for different lane surfaces, in the case of a common pavement and $v \leq 30$ km/h $\Rightarrow D_{StrO} = 3$ dB(A);

D_{Stg} = correction for slopes or descents, for 13% $\Rightarrow D_{Stg} = 4.8$ dB(A);

D_E = correction for mirror sound sources, here not to be taken into account.

For the access or the exit within the ramp zone consequently the following emission equivalent level is resulting:

$$L_{m,E} = 47.3 \text{ dB(A)} - 8.8 \text{ dB(A)} + 3.0 \text{ dB(A)} + 4.8 \text{ dB(A)} = 46.3 \text{ dB(A)}.$$

The length-specific sound power level $L_{W',1h}$ of the access or exit arises in consideration of a conversion summand of 19 dB(A) (s. sect. 7.2.2, formula 4) to:

$$L_{W',1h} = L_{m,E} + 19 \text{ [dB(A)]} = 46.3 + 19 \text{ [dB(A)]} = 65.3 \text{ dB(A)}.$$

A 3.1.1.2 Traffic in Front of the Ramp

In the zone of the planar exit and access driveways in front of the ramp zone, the correction term for slopes and descents is dropped compared with the calculation in the sect. A 3.1.1.1. The emission equivalent level of the access or exit is therefore:

$$L_{m,E} = 47.3 \text{ dB(A)} - 8.8 \text{ dB(A)} + 3.0 \text{ dB(A)} = 41.5 \text{ dB(A)}.$$

Correspondingly the length-specific sound power level $L_{W',1h}$ results to:

$$L_{W',1h} = L_{m,E} + 19 \text{ dB(A)} = 41.5 \text{ dB(A)} + 19 \text{ dB(A)} = 60.5 \text{ dB(A)}.$$

A 3.1.1.3 Passing Over the Rain Gutter

At the beginning of the access ramp, immediately in front of the garage, there is a rain gutter emitting short-time disturbing noise peaks when being passed over by the motorcars. According to sect. 8.3.3, in the case of open access ramps a point acoustic source can be assumed for the passages in the middle of the rain gutter with a sound power level $L_{W\text{Teq},1h}$ of 72 dB(A) for one event of passing over a gutter per hour. For 20 events of passing over per hour therefore a sound power level L_W is resulting of:

$$L_W = L_{W\text{Teq},1h} + 10 \cdot \lg 20 [\text{dB(A)}] = 72 \text{ dB(A)} + 13 \text{ dB(A)} = 85 \text{ dB(A)}.$$

A 3.1.1.4 Opening the Garage Roller Gate

The garage in our calculation example in addition shall have a garage roller gate which also emits short-time disturbing noise peaks when opening and closing it. According to sect. 8.3.4, a point acoustic source can be assumed for it in the middle of the garage gate with a sound power level $L_{W\text{Teq},1h}$ of 69 dB (A). Due to the assumed 20 enterings and leavings per hour, with the upper estimation that each driving motion takes place separately, therefore altogether 40 opening or closing movements of the roller gate are resulting and from this a sound power level L_W is resulting of:

$$L_W = L_{W\text{Teq},1h} + 10 \cdot \lg 40 [\text{dB(A)}] = 69 \text{ dB(A)} + 16 \text{ dB(A)} = 85 \text{ dB(A)}.$$

A 3.1.2 Calculation of the Noise Immissions by the Open Ramp

The four legs of the driving course respectively are provided with the corresponding length-specific sound power level calculated in sect. A 3.1.1. In addition, immediately in front of the garage the point acoustic sources of the passing over the rain gutter and the opening and closing of the roller gate go into action. The calculation of the sound propagation and of the noise immissions at the two immission sites of the adjacent dwelling houses, depicted in the location outline, is performed according to the annex of the TA Lärm in accordance with the guideline DIN ISO 9613-2.

In analogy to the example of the company parking area in annex 2, for the determination of the rating levels for the daytime period with an increased need of rest (in accordance with sect. 6.5 of the TA Lärm, these are the periods from 6 a.m. until 7 a.m. and from 20 p.m. to 22 p.m. on workdays) a surcharge in an amount of 6 dB(A) follows which, related to the altogether 16-hour-period of assessment, causes a surcharge in an amount of approx. 1.9 dB(A).

The detailed representation of the determination of the partial rating levels $L_{r,i}$ from the six issuers (two driveways respectively in front of and on the ramp, rain gutter, garage roller gate) is renounced here, since it is carried out in analogy to the example of the company parking area and is performed automatically by modern sound engineering calculation programs.

With regard to possible measures for the noise immissions` reduction, however, the partial rating levels caused by the individual issuers are of importance. A useful procedure for the planning of sound protective measures consists in providing measures for the level reduction at first at that issuer who causes the highest partial rating levels. If this doesn't suffice yet, the next step consists of the reduction of the second loudest issuer etc.

So for the two dwelling houses, each assumed to have two main storeys (IO 1: neighbour building lateral besides the underground car park ramp; IO 2: building lying in prolongation to the ramp), the partial rating levels due to the individual issuers and the total rating levels, both listed in Tab. 38, are following.

Tab. 38:
Partial and total rating
levels of the calculation
example of an open
underground
car park ramp

Immission site		Partial rating level from . . . [dB(A)]			Total rating level [dB(A)]
IO no.	Floor	Driveway	Rain gutter	Roller gate	
1	EG	54.9	53.3	53.1	58.6
	OG	53.9	52.9	52.7	58.0
2	EG	51.6	47.3	47.9	54.2
	OG	51.0	49.3	49.6	54.8

The determined rating levels show that at the dwelling house next-door to the underground car park access the immission reference value of the TA Lärm of 55 dB(A) for general residential areas is exceeded by up to 3.6 dB(A), whereas at the residential building lying opposite to the access this reference value can be kept.

In order to improve the sound situation at least at the immission site 1, for the access to the underground car park the enclosure of the ramp zone presents itself as an active sound protective measure for logical reasons, since through this particularly the partial rating levels of the driveway and of the rain gutter, being not low noise and remaining below at the entrance of the underground car park, can be reduced.

A 3.1.3 Calculation of the Maximum Level During Short-Time Noise Peaks

For the calculation of the occurring maximum levels during short-time noise peaks, on the one hand the peak sound power levels mentioned in the sect. 8.3 of the open ramp, the passing over the rain gutter and the opening of the garage gate must be consulted:

Driveway in the ramp zone:	94 dB(A);
passing over the rain gutter in case of open ramp:	101 dB(A);
opening the garage gate:	97 dB(A).

Since the noise peaks due to the passing over the rain gutter and the opening of the garage gate are emitted virtually at the same position, for the peak level consideration only the louder noise is interesting. For the driving motions in front of the ramp (private street), the maximum sound power level (s. Tab. 35) is calculated as follows when taking as a basis the accelerated driving past as the relevant noise source:

$$L_{W,max} = L_{max}^{(7,5m)} + 25.5 \text{ dB(A)} = 67 \text{ dB(A)} + 25.5 \text{ dB(A)} = 92.5 \text{ dB(A)}.$$

The smallest distances to the driveways resp. to the rain gutter are:
 Neighbouring building (IO 1):
 6 m to the driveway; 10 m to the rain gutter;
 building situated opposite (IO 2):
 4 m to the driveway; 34 m to the rain gutter.

Under consideration exclusively of the attenuation due to a geometric propagation, from this follows according to DIN ISO 9613-2 for the drive-way on the ramp concerning IO 1:

$$L_{r,max} = L_{W,max} - A_{div} + D_C = 94 \text{ dB(A)} - 26.6 + 3 \text{ dB (A)} = 70.4 \text{ dB(A)}.$$

Analogously at the IO 1, in view of the noise peaks occurring when passing over the rain gutter, a level follows of:

$$L_{r,max} = L_{W,max} - A_{div} + D_C = 101 \text{ dB(A)} - 31.0 + 3 \text{ dB(A)} = 73.0 \text{ dB(A)}.$$

The calculation shows the following peak immission levels at the IO 2:
 Concerning the driveway (plane zone): 74.0 dB(A);
 concerning the rain gutter: 62.4 dB(A).

Therefore in any cases the daytime immission reference value (55 dB(A)) in general residential areas is exceeded by single noise peaks only by up to 19.0 dB(A). In accordance with point 6.1 of the TA Lärm, during the day single noise peaks are allowed to exceed the immission reference value however by up to 30 dB(A) so that already in the case of the open ramp the maximum level criterion of the TA Lärm is kept. If the underground car park exit would be travelled on also at night, it would not be kept since at night the maximum level must not lie above the immission reference value for the night (here: 40 dB(A)) by more than 20 dB(A).

A 3.2 Calculation of the Enclosed Ramp

A 3.2.1 Calculation of the Noise Emissions in the Case of an Enclosed Ramp

A 3.2.1. Traffic on the Enclosed Ramp

In order to reduce the noise immissions particularly for the directly adjacent dwelling house (IO 1), the complete ramp zone of the underground car park access shall be enclosed (site plan fig. 40). According to sect. 8.3.2, the planespecific sound power

level $L_{W^*,1h}$ on the enclosure's opening amounts 50 dB(A)/m² for one driving motion per hour on the ramp.

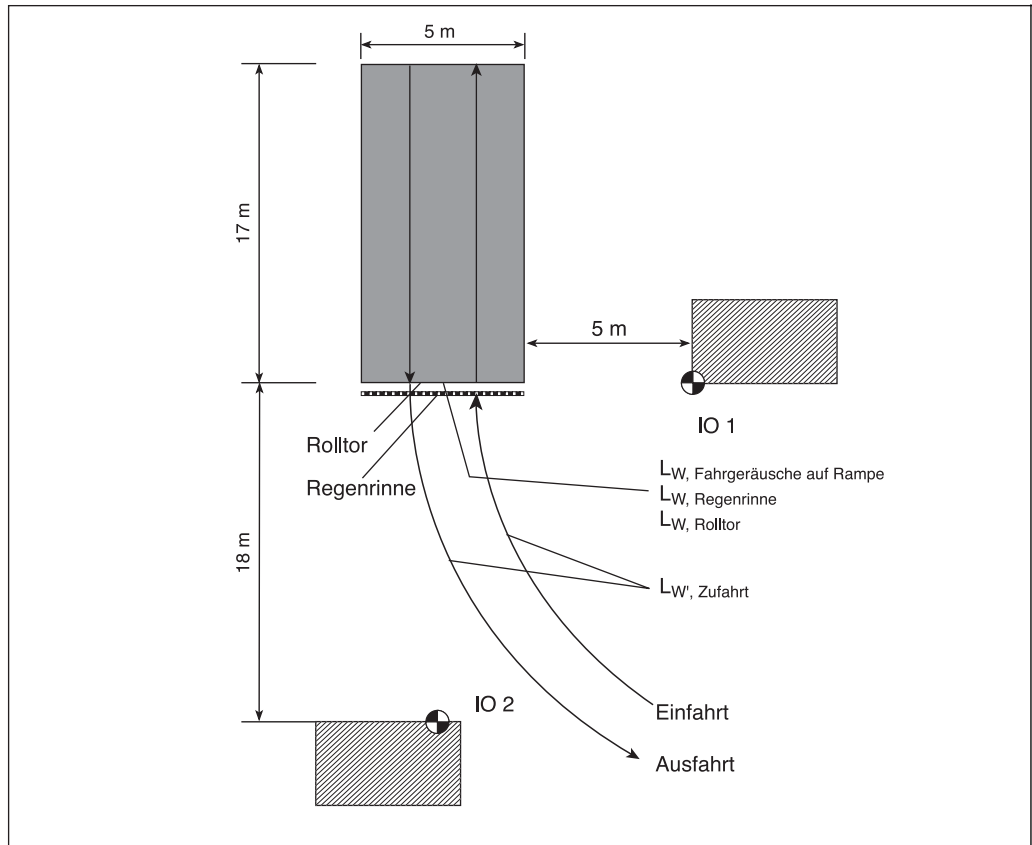


Fig. 40: Site plan for the calculation example of an enclosed underground car park ramp

At this, particularly the sound radiation's directivity must be taken into account since the enclosed access ramp works like an acoustic funnel, so to speak. Thus in the prolongation of the ramp values were measured higher by 8 dB(A) than besides the ramp (cf. sect. 7.2.3). For the dwelling house adjacent to the underground car park access, the plane-specific sound power level $L_{W^*,1h}$ for one driving motion per hour on the ramp therefore is only 42 dB(A)/m².

In our example hourly still 10 vehicles each shall drive into the garage and 10 vehicles go out from the garage. The plane-specific sound power levels, resulting from this for the two immission sites, increase according to the number of accesses and exits by addition of the term:

$$10 \cdot \lg 20 = +13 \text{ dB(A)/m}^2.$$

Assuming the area size of the enclosure's opening to be 10 m² (e.g. this corresponds to a height of 2 m and a breadth of 5 m), for the opening, due to the driving motions on the ramp, sound power levels L_W follow of:

65 dB(A) for the IO 1 situated besides;

73 dB(A) for the IO 2 situated in prolongation of the ramp.

Remark:

The noise emissions on the access in front of the ramp don't change compared to sect. A 3.1.1.2.

A 3.2.1.2 Passing Over the Rain Gutter in the Case of an Enclosed Ramp

According to sect. 8.3.3, in the case of an enclosed access ramp for the passings over a rain gutter, situated above in front of the garage entrance, a point acoustic source with a sound power level $L_{WTeq,1h}$ of 63 dB(A) can be assumed for one passing over the gutter per hour. Therefore for 20 passings per hour a sound power level L_W follows of:

$$L_W = L_{WTeq,1h} + 10 \cdot \lg(n) \text{ [dB(A)]} = 63 \text{ dB(A)} + 13 \text{ dB(A)} = 76 \text{ dB(A)}.$$

It has to be checked, however, whether the above lying drainage gutter is required at all in the case of a proper planning of the gradient ratios. If necessary, a rain gutter must be installed in a low noise construction.

A 3.2.1.3 Opening the Garage Roller Gate in the Case of an Enclosed Ramp

After the ramp's enclosure, the garage roller gate will be transferred to the upper end of the ramp, for logical reasons. In view of the disturbing noise impulses, emitted when opening and closing, nothing therefore changes. For this a point acoustic source in the middle of the ramp's opening with a sound power level $L_{WTeq,1h}$ of 69 dB(A) will be assumed. With altogether 40 opening or closing motions of the roller gate, from this, in analogy to the open ramp, on the level of the ramp's opening a sound power level L_W results of:

$$L_W = L_{WTeq,1h} + 10 \cdot \lg(n) \text{ [dB(A)]} = 69 \text{ dB(A)} + 16 \text{ dB(A)} = 85 \text{ dB(A)}.$$

A 3.2.2 Calculation of the Noise Immissions in the Case of an Enclosed Ramp

The two sections of the driving course in front of the ramp are provided respectively with the corresponding length-specific sound power level calculated in the sect. A 3.1.1.2. Moreover the point acoustic sources for the passing over the rain gutter and the opening resp. closing of the roller gate go into action as well as the plane sound source within the zone of the roller gate (cf. sect. 8.3.2) at the opening of the enclosed ramp. The calculation of the noise immissions at the two immission sites of the adjacent dwelling houses is carried out again according to the guideline DIN ISO 9613-2.

In the case of the enclosed ramp, under consideration of a roller gate placed at the upper end of the ramp enclosure, for the two dwelling houses, supposed to have two main storeys each, the following rating levels result:

IO 1: ground floor:	60.4 dB(A);
first floor:	59.4 dB(A);
IO 2: ground floor:	55.8 dB(A);
first floor:	55.3 dB(A).

The results found out show that due to the loud roller gate's transfer closer to the immission sites, despite the underground car park access's enclosure, at both adjacent dwelling houses the rating levels were increased by 1 to 2 dB(A) so that the immission reference value of the TA Lärm of 55 dB(A) for general residential areas now is exceeded at both dwelling houses.

Only after repair or replacement of the roller gate by a more quiet construction (e.g. sectional or swinging gate), the noises from the garage gate containing impulse character can be avoided to a great extent. Therefore, without consideration of the roller gate noises, at the two dwelling houses the following rating levels arise:

IO 1: ground floor: 51.1 dB(A);
first floor: 50.2 dB(A);
IO 2: ground floor: 51.8 dB(A);
first floor: 50.9 dB(A).

The immission reference value of the TA Lärm therefore is fallen short of at the two dwelling houses considerably. Compared with the open ramp with roller gate noises, a reduction of the rating levels by 7 to 8 dB(A) at the nearer immission site and by 2 to 4 dB(A) by the remoter immission site arises.

A 3.2.3 Calculation of the Maximum Level During Short-Time Noise Peaks

After the underground car park access's enclosure, in addition to the driveways outside the ramp zone, also the noise peaks when opening and closing the garage roller gate on top at the beginning of the ramp, due to the proximity to the two immission sites, are constituting a disturbing noise source.

The smallest distances to the middle of the roller gate situated on top are

for the nearer building: 8 m;
for the remoter building: 18 m.

From this, going out from the peak sound power level of 97 dB(A), given in sect. 8.3.4, the following immission peaks result at the two buildings:

for the nearer building:

$$L_{r,max} = 97 \text{ dB(A)} - 29.1 + 3 \text{ dB(A)} = 70.9 \text{ dB(A)};$$

for the remoter building:

$$L_{r,max} = 97 \text{ dB(A)} - 36.1 + 3 \text{ dB(A)} = 63.9 \text{ dB(A)}.$$

Also in this case (loud roller gate) the maximum level criterion is kept only during the day.

Annex 4: Example of the Sound Engineering Calculation of a Multi-Storey Car Park

In this calculation example the sound immission shall be calculated at a residential building lying opposite to a multi-storey car park whose lower floor is closed and whose two upper floors are open (site plan fig. 41). The calculation with the program IMMI 5.3.1a thereby follows the procedure suggested in the sect. 8.4 in which only the two open floors are taken into account, since from the closed floor distinctly lower and therefore in a sound engineering way negligible noise emissions are reaching outward.

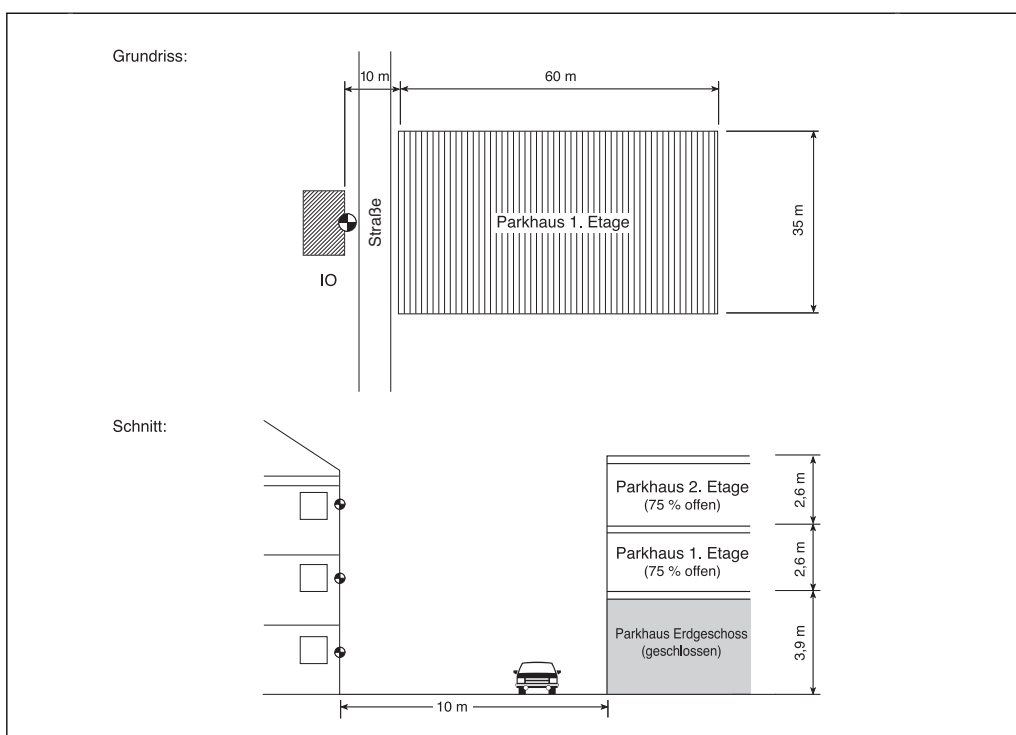


Fig. 41:
Site plan and sectional
view for the calculation
example of an open
multi-storey car park

The following parameters are taken as a basis for the calculations:

- Per parking level, the multi-storey car park shall have 100 carports.
- Each parking floor has a size of 60 m in breadth and 35 m in length.
- The height of the park floors amounts 2.6 m, at what 75% of the side walls shall be open on the two upper decks.
- Ceiling and floor surfaces as well as the remaining balustrades consist of concrete (no sound decreasing measures existing).
- The use of the multi-storey car park is limited to the daytime period (6 a.m. – 22 p.m.).
- In the west of the multi-storey car park, a residential house in a general residential area, situated on the opposite side of the street, works as the operative immission site.

As pictured in the sect. 8.4, the sound engineering forecast for multi-storey car parks can be made in the following four calculation steps:

1. Determination of the sound power level of the parking and passing-through expanses per parking storey

2. Determination of the interior sound level per parking floor according to the guideline VDI 2571
 3. Determination of the emitted sound power according to the guideline VDI 2571
 4. Calculation of the sound propagation in accordance with DIN ISO 9613-2
- Since the two open parking floors of our multi-storey car park are identical in view of size, number of carports and the structural substance, the calculation steps 1 to 3 can be restricted to one parking floor. With regard to the surcharges for the parking area type and for containing impulse character, the multi-storey car park must be regarded as a P + R area.

A 4.1 Determination of the Sound Power Level of the Parking and Passaging-Through Expanses per Parking Storey

At first the plane-specific sound power level $L_{W''}$ of one parking floor has to be determined (cf. sect. 8.2.1, formula 11a):

$$L_{W''} = L_{W0} + K_{PA} + K_I + K_D + 10 \cdot \lg(B \cdot N) - 10 \cdot \lg(S / 1\text{m}^2) \text{ [dB(A)]}$$

with

- L_{W0} = basic value of one parking process on P + R areas = 63 dB(A);
- K_{PA} = surcharge for the parking area type, on P + R areas = 0 dB(A) (see Tab. 34);
- K_I = surcharge for the impulse character, on P + R areas = 4 dB(A) (see Tab. 34);
- K_D = surcharge for the driving lanes
= $2.5 \cdot \lg(f \cdot B - 9)$ [dB(A)];
- B = reference value = number of the carports on a parking level = 100;
- f = carports / unit of reference value;
here: $f = 1$
- N = motion frequency, for multi-storey car parks during the day (6 a.m. – 22 p.m.) = 0.47 (cf. Tab. 33);
- S = area size of the parking level in $\text{m}^2 = 35 \text{ m} \cdot 60 \text{ m} = 2.100 \text{ m}^2$.

The surcharge for the driving lanes on one of the open parking floors is therefore:

$$\begin{aligned} K_D &= 2.5 \cdot \lg(f \cdot B - 9) \text{ [dB(A)]} = 2.5 \cdot \lg(1 \cdot 100 - 9) \text{ [dB(A)]} \\ &= 2.5 \cdot \lg 91 \text{ [dB(A)]} = 4.9 \text{ dB(A)}. \end{aligned}$$

Then, for the plane-specific sound power level the following value is resulting:

$$\begin{aligned} L_{W''} &= L_{W0} + K_{PA} + K_I + K_D + 10 \cdot \lg(B \cdot N) - 10 \cdot \lg(S / 1\text{m}^2) \text{ [dB(A)]} \\ &= 63 + 0 + 4 + 4.9 + 10 \cdot \lg 47 - 10 \cdot \lg(2100) \text{ [dB(A)]} \\ &= 71.9 + 16.7 - 33.2 \text{ [dB(A)]} \\ &= 55.4 \text{ dB(A)}. \end{aligned}$$

A 4.2 Determination of the Interior Sound Level per Parking Storey

For the determination of the average interior room level prevailing on one parking floor according to the guideline VDI 2571, at first the equivalent absorption area must be calculated. In accordance with the specifications, 75% of the wall area shall

be open. This open wall area an absorption coefficient $\alpha_{W,0} = 1$ is assigned to. Balustrade, ceiling and floor shall consist of concrete with an absorption coefficient $\alpha_{Bet} = 0.03$.

For the partial areas of one parking floor the following area sizes result:

$$\begin{aligned} \text{Wall, open: } A_{W,0} &= 0.75 \cdot 2 \cdot (35 \text{ m} + 60 \text{ m}) \cdot 2.6 \text{ m} = 370.5 \text{ m}^2; \\ \text{wall base: } A_{W,Bet} &= 0.25 \cdot 2 \cdot (35 \text{ m} + 60 \text{ m}) \cdot 2.6 \text{ m} = 123.5 \text{ m}^2; \\ \text{ceiling: } A_D &= 35 \text{ m} \cdot 60 \text{ m} = 2.100 \text{ m}^2; \\ \text{floor: } A_B &= 35 \text{ m} \cdot 60 \text{ m} = 2.100 \text{ m}^2. \end{aligned}$$

For the complete equivalent absorption area A of one parking floor is:

$$\begin{aligned} A &= A_{W,0} \cdot \alpha_{W,0} + A_{W,Bet} \cdot \alpha_{Bet} + A_D \cdot \alpha_{Bet} + A_B \cdot \alpha_{Bet} \text{ [m}^2\text{]} = \\ &= 370.5 \text{ m}^2 \cdot 1 + (123.5 \text{ m}^2 + 2.100 \text{ m}^2 + 2.100 \text{ m}^2) \cdot 0.03 \\ &= 500.2 \text{ m}^2 \end{aligned}$$

The calculation of the interior noise level L_I is carried out according to the equation (6) of the VDI 2571:

$$L_I \approx L_{W'} + 14 + 10 \cdot \lg(0.16/A) \text{ [dB(A)]}$$

with

$$\begin{aligned} L_{W'} &= L_{W''} + 10 \cdot \lg(S / 1\text{m}^2) \text{ [dB(A)]} \\ &= 55.4 + 10 \cdot \lg(2.100) \text{ [dB(A)]} = 88.6 \text{ dB(A);} \\ A &= 500.2 \text{ m}^2. \end{aligned}$$

The interior noise level on one parking floor is therefore calculated in our example to:

$$\begin{aligned} L_I &\approx L_{W'} + 14 + 10 \cdot \lg(0.16/A) \text{ [dB(A)]} \\ &= 88.6 + 14 + 10 \cdot \lg(0.16/500) \text{ [dB(A)]} = 67.7 \text{ dB(A)}. \end{aligned}$$

A 4.3 Determination of the Emitted Sound Power

For the determination of the noise immissions at the operative immission site, due to the high acoustic attenuation index of the concrete areas, only the sound energy emitted through the open lateral faces is of importance, in which the determination of the plane-specific sound power level emitted through the open lateral faces is carried out according to the equation (7b) of the VDI 2571:

$$L_{W''} = L_I - R'_{W'} - 4.$$

Since the weighted acoustic attenuation index of the open lateral faces is $R'_{W'} = 0$ dB, for the open lateral faces of the multi-storey car park's 1st and 2nd floor a plane-specific sound power level of 63.7 dB(A) is calculated.

A 4.4 Calculation of the Sound Propagation

The multi-storey car park is calculated in analogy to a factory building, in which the four open lateral faces of the two upper floors respectively are defined as plane acoustic sources on which the emitted plane-specific sound power levels determined in the sect. A 4.3 must be set.

Under consideration of the respective area size, for the multi-storey car park's narrow and broad facades per storey the following sound power levels result from the plane-specific sound power level:

facade side (bF):

$$\begin{aligned} L_W &= L_{W''} + 10 \cdot \lg(S_{bF}/1\text{m}^2) \text{ [dB(A)]} \\ &= 63.7 + 10 \cdot \lg(0.75 \cdot 2.6 \cdot 60) \text{ [dB(A)]} \\ &= 63.7 + 10 \cdot \lg 117 \text{ [dB(A)]} = 63.7 + 20.7 \text{ [dB(A)]} = 84.4 \text{ dB(A)} \end{aligned}$$

narrow facade side (sF):

$$\begin{aligned} L_W &= L_{W''} + 10 \cdot \lg(S_{sF}/1\text{m}^2) \text{ [dB(A)]} \\ &= 63.7 \text{ dB(A)} + 10 \cdot \lg(0.75 \cdot 2.6 \cdot 35) \text{ [dB(A)]} \\ &= 63.7 + 10 \cdot \lg 68.25 \text{ [dB(A)]} = 63.7 + 18.3 \text{ [dB(A)]} = 82.0 \text{ dB(A)} \end{aligned}$$

The calculation of the sound propagation and of the noise immissions at the immission site resp. on the house side turned towards the multi-storey car park is carried out in accordance with the annex of the TA Lärm according to the guideline DIN ISO 9613-2.

Since the residential building lies as a three-storied building in a general residential area, for the determination of the rating levels of the daytime period with an increased need of rest (in accordance with point 6.5 of the TA Lärm, on workdays the periods from 6 a.m. to 7 a.m. and from 20 p.m. to 22 p.m.) a surcharge in the amount of 6 dB(A) is set. Related to the altogether 16-hour-period of assessment, from this a surcharge in an amount of 1.9 dB(A) arises.

The determination of the partial rating levels $L_{r,i}$ from the single issuers i (two parking floors with four open lateral faces each) is carried out according to DIN ISO 9613-2. The calculation method for summarized levels was already explained with the example of a company parking area more precisely.

In our example the following rating levels result at the immission site situated in a distance of about 10 m to the west facade of the multi-storey car park:

ground floor: 56.4 dB(A);
1st floor: 56.8dB(A);
2nd floor: 56.7 dB(A).

Because of the reflections on the street suggested to be totally sound reflecting, the rating levels are lying higher on the ground floor than in the upper floors. The immission reference value of the TA Lärm of 55 dB(A) for general residential areas during the day is therefore exceeded by up to 2 dB(A). A compliance of the immission reference value in a relatively simple way could be achieved for example by a closing of the facade side, which is turned towards the immission site, by a congruous raising of the massive balustrade. If buildings also worthy of protection exist on the opposite side of the multi-storey car park's other facades within the local area of the multi-storey car park, by sound absorbing coverings of the storey ceilings and, if necessary, of the balustrades, too, the most effective improvement of the noise situation can be achieved.

A 4.5 Maximum Level Criterion

The simulation measurements have shown that the maximum level on the outside in front of an open multi-storey car park is approximately just as high as the maximum level of a parking area at ground level (cf. section 8.4.5). The operative noise source in our example is the banging of the doors in the 2nd upper floor in a distance of 13 m to the immission site. Thus the maximum level here is just as high as the one calculated in the annex 2 under A 2.3., i.e. 67.2 dB(A). The daytime-peak-level criterion so is fallen short of by 17.8 dB(A).

Annex 5: Measurement Results of Busses 1999 Partial Processes During Parking Motions Sound power levels L_{Weq} for 1 process/hour and surcharges K_1

Partial process	Number of partial measurements	L_{Weq} [dB(A)]	K_1^* [dB(A)]
Standard bus (Kässbohrer-Setra 5212 H) Parking movement (departure) ⁶⁶⁾	12	72.8	4.3
Door shutting ⁶⁷⁾	2	60.9	1.3
Starting	2	63.8	8.2
Engine braking noise/compressed air ⁶⁹⁾	-	63.9	7.0
Stand noise (30sec./h)	3	72,1	1,2
Departure	5	71.7	5.3
Low corridor citybus with nat. gas impulse Parking movement (departure)	11	69.9	3.4
Door shutting	2	60.9	1.3
Starting ⁶⁸⁾	2	63.8	8.2
Engine braking noise/compressed air ⁶⁹⁾	-	63.9	7.0
Stand noise (30sec./h)	3	67.6	1.2
Departure	4	68.1	4.1

**Annex 6:
Measurement Results of Entering and
Leaving Motorcars at the Tested Underground Car Park Ramps**

	Number of measurements	Average meas. time [sec.]	L _{AFmax} [dB(A)]	L _{AFeq} [dB(A)]	L _{AFTeq} [dB(A)]	L _{AFeq, 1h} [dB(A)]	L _{AFTeq, 1h} [dB(A)]	K _f [dB(A)]
Underground car park ramp (TG) closed I, measuring point (MP) 1 lateral to gate approx. 5 m								
Entrance	19	62	73.8	56.9	66.1	39.3	48.4	9.1
Exit	14	50	73.7	56.7	65.9	38.1	47.3	9.2
TG closed I, MP2 opposite to gate approx. 17 m								
Entrance	19	66	65.6	52.7	59.2	35.3	41.8	6.5
Exit	13	56	67.8	53.0	60.6	34.9	42.5	7.6
TG closed II, MP1 lateral to gate approx. 5 m								
Entrance TG east	2	48	58.3	48.8	53.9	30.0	35.1	5.1
Exit TG east	9	20	61.7	53.1	59.1	30.5	36.6	6.1
Exit TG west	9	18	57.9	50.8	55.8	27.6	32.6	5.0
TG closed II, MP2 in front of gate approx. 8 m								
Entrance TG east	2	48	65.4	51.0	58.2	32.2	39.4	7.3
Exit TG east	9	22	68.6	59.4	64.4	37.3	42.3	5.0
Exit TG west	9	17	66.1	57.0	62.4	33.8	39.1	5.4
TG open I, MP1 lateral to ramp								
Entrance	11	37	71.4	58.1	65.1	38.2	45.2	7.1
Exit	29	28	71.1	60.7	66.4	39.7	45.3	5.7
TG open I, MP2 in front of ramp								
Entrance	11	28	66.6	56.3	63.4	35.1	42.2	7.1
Exit	23	24	68.3	59.3	64.5	37.6	42.8	5.2
TG open II, MP1 lateral to ramp								
Entrance	16	14	73.9	62.6	70.8	38.5	46.8	8.2
Exit	38	15	70.2	61.7	67.9	37.9	44.1	6.2
TG open II, MP2 in front of ramp								
Entrance	16	14	69.6	62.0	68.0	37.8	43.9	6.0
Exit	38	15	66.7	60.9	65.2	37.1	41.5	4.4

Annex 7:
Measurement Results at the Tested Multi-Storey Car Parks
During Simulated Parking Processes; Energetic average values
of the sound levels during one vehicle motion respectively ⁷⁰⁾

Type of multi-storey car park	Number of measurements	Average meas. time [sec.]	L _{AFmax} [dB(A)]	L _{AFeq} [dB(A)]	L _{AFTeq} [dB(A)]	L _{AFeq, 1h} [dB(A)]	L _{AFTeq, 1h} [dB(A)]	K _I [dB(A)]
Multi-storey car park "open", without sound reducing measures; measuring point (MP) 7,5 m inside								
Approaching motorcar (Otto engine)	6	27	83.8	65.8	75.4	44.5	54.1	9.6
Leaving motorcar (Otto engine)	5	26	80.6	65.4	75.6	44.0	54.1	10.1
Approaching motorcar (Diesel engine)	3	29	76.0	67.3	73.0	46.4	52.1	5.7
Leaving motorcar (Diesel engine)	4	36	77.2	68.3	74.4	48.2	54.4	6.1
Multi-storey car park "open", without sound reducing measures; MP on the outside in front of facade								
Approaching motorcar (Otto engine)	3	27	75.7	60.2	70.8	38.9	49.5	10.6
Leaving motorcar (Otto engine)	4	26	75.4	60.7	71.0	39.3	49,6	10.3
Approaching motorcar (Diesel engine)	3	32	71.7	60.0	66.8	39.4	46.3	6.9
Leaving motorcar (Diesel engine)	4	37	72.9	62.2	68.3	42.3	48.4	6.1
M.-s. c. p. "open" with parking level, with sound absorbing ceiling; parking process on basement north, MP 7,5 m inside								
Approaching motorcar (Otto engine)	5	23	70.4	55.3	61.7	33.4	39.8	6.3
Leaving motorcar (Otto engine)	5	27	69.1	56.2	64.5	34.9	43.2	8.3
Approaching motorcar (Diesel engine)	6	24	70.3	59.0	63.4	37.3	41.7	4.4
Leaving motorcar (Diesel engine)	6	25	71.0	63.4	68.9	41.9	47.3	5.4
M.-s. c. p. "open" with parking level, with sound absorbing ceiling; parking process on basement north, MP outside								
Approaching motorcar (Otto engine)	3	24	54.0	46.2	49.1	24.5	27.4	3.0
Leaving motorcar (Otto engine)	5	30	54.7	46.2	50.8	25.4	30.0	4.6
Approaching motorcar (Diesel engine)	3	28	57.7	50.0	54.8	28.9	33.7	4.8
Leaving motorcar (Diesel engine)	4	28	60.8	49.7	55.6	28.5	34.5	6.0
M.-s. c. p. "open" with parking level, with sound absorbing ceiling; parking process on basement south, MP 7,5 m inside								
Approaching motorcar (Otto engine)	4	19	67.6	55.4	64.2	32.7	41.4	8.8
Leaving motorcar (Otto engine)	4	25	68.3	58.2	64.7	36.7	43.1	6.5
Approaching motorcar (Diesel engine)	5	21	70.3	59.1	64.2	36.8	41.9	5.1
Leaving motorcar (Diesel engine)	2	23	74.5	64.2	71.3	42.3	49.4	7.1
M.-s. c. p. "open" with parking level, with sound absorbing ceiling; parking process on upper floor north, MP 7.5 m								
Approaching motorcar (Otto engine)	6	22	64.7	54.2	58.8	32.2	36.7	4.6
Leaving motorcar (Otto engine)	7	23	65.5	55.9	62.7	34.0	40.8	6.8
Approaching motorcar (Diesel engine)	5	16	67.9	61.2	66.4	37.7	42.9	5.1
Leaving motorcar (Diesel engine)	5	26	71.7	62.8	68.2	41.4	46.8	5.4
M.-s. c. p. "open" with parking level, with sound absorbing ceiling; parking process on upper floor north, MP outside								
Approaching motorcar (Otto engine)	5	23	51.8	46.2	48.8	24.3	26.9	2.6
Leaving motorcar (Otto engine)	6	23	54.3	45.7	49.9	23.7	27.8	4.2
Approaching motorcar (Diesel engine)	4	18	55.1	49.2	53.3	26.2	30.4	4.2
Leaving motorcar (Diesel engine)	4	26	55.0	47.3	53.0	25.8	31.6	5.7
Multi-storey car park on basement, without sound reducing measures; MP 7.5 m inside								
Approaching motorcar (Otto engine, loud door shutting)	2	26	81.1	63.6	75.5	42.2	54.1	11.9
Leaving motorcar (Otto engine, loud door shutting)	2	59	79.2	64.1	72.6	46.2	54.7	8.5
Approaching motorcar (Otto engine)	1	31	75.4	60.8	71.0	40.2	50.4	10.2
Leaving motorcar (Otto engine)	1	54	77.2	63.5	70.3	45.3	52.1	6.8
Approaching motorcar (Diesel engine)	2	30	77.9	67.2	72.2	46.4	51.4	5.0
Leaving motorcar (Diesel engine)	2	73	76.6	68.8	72.2	51.8	55.2	3.4

**Annex 8:
Remarks**

- 1) These calculation steps – particularly the determination of the respective sound immissions – are carried out in general with suitable software programs [20].
- 2) Multi-storey car parks in the present study are denoted to be “open” when being marked by the radiation of the parking noises in the multi-storey car park through for the most part open faces. Since the open style of multi-storey car parks makes possible an economical ventilation and degassing, it is chosen as a rule.
- 3) As already described in sect. 3.1.3, since the 4th edition in the case of the parking area types purchase market, restaurant, discotheque and hotel no longer a reference to the number of the carports is made, but to the reference quantities net selling area, net restaurant room resp. number of guest beds.
- 4) The inquiries were performed during the time periods listed in the synoptical tables 4 to 12. For the evaluations it was assumed that in the context of the evaluations all vehicle motions during the relevant time periods were recorded.
- 5) In table 33, for sound engineering forecasts of parking areas, underground car parks and multi-storey car parks, reference values for motion frequencies of different parking area types are recommended.
- 6) Maximum values bold (without the peak values determined on “Aktionstagen” at discounting markets).
- 7) two partial areas with one entrance each (= exit).
- 8) private carports belonging to the housing area.
- 9) The reference quantity net restaurant room cannot be indicated for four discotheques since partly the information was denied resp. the discotheques meanwhile are no more operated.
- 10) Reference data not available.
- 11) Only the carports provided by the discotheque operator are taken into account.
- 12) Information of the Chamber of Industry and Commerce (Industrie- und Handelskammer) of Augsburg and Schwaben (according to the definition of the Institute for Trade Research (Institut für Handelsforschung) of the university of Köln).
- 13) partly, if available, including public carports.
- 14) calculated by means of the number of seats with the factor 1.2 m² of net restaurant room per seat.
- 15) Hotel / inn with a restaurant with external effect, hotel was inquired separately.

-
- 16) without restaurant.
 - 17) neighbouring restaurant, was also visited by hotel guests.
 - 18) with restaurant, external effect due to the size of the hotel with 330 beds not clear.
 - 19) s. table 9 (restaurants: motions per 10 m² of net restaurant room and hour) and table 10 (hotels: motions per bed and hour).
 - 20) Total number of the forecasted motions (sum restaurant and hotel), calculated by means of the corresponding reference quantities and maximum motion frequencies (see table 9 and 10 as well as footnote 13).
 - 21) calculated by means of the number of seats with the factor 1.2 m² of net restaurant room per seat.
 - 22) 816 carports free of charge with unlimited parking time,
484 carports with a maximum parking time of 4 hours,
140 carports with a maximum parking time of 2 hours,
351 carports in the multi-storey car park leased out to long-term tenants.
 - 23) chargeable.
 - 24) Values < 0,005.
 - 25) maximum parking time 2 hours.
 - 26) Averaging over three probe sites; thereby for the multi-storey car park Rosenheim the average value was taken into account.
 - 27) Measurement of simulated complete parking processes.
 - 28) The share of the diesel vehicles (motorcars and trucks) in the newly registered vehicles meanwhile is 40% (according to: radio station "Bayern 5" on 02.03.2003, 8.45 a.m.).
 - 29) without autocycle resp. moped (with autocycle resp. moped 50.7%).
 - 30) up to the 4th edition: added up energetically from partial emission levels; now: result of new measurements of complete parking processes (cf. sect. 6.1.2).
 - 31) Approaching or leaving resp. partial processes.
 - 32) mean average sound power level.
 - 33) $K_I^* = L_{WTeq} - L_{Weq}$ (measuring point in a distance of 19 m).
 - 34) in addition determined metrologically: cooling unit in operation: $L_W = 97$ dB(A).
 - 35) The average maximum level is the energetic mean average value of the maximum levels of the separate events, s. DIN 45642 annex A.1 [16].

- 36) Simulation purchase market.
- 37) set for the normalization at each tenth departure.
- 38) set for the normalization at each fifth departure (share of two-stroke vehicles approx. 20% without autocycle/ moped).
- 39) Gradient of the examined ramps: 11.7 to 13.0 %,
cf. RLS-90 [5]: surcharge for gradients and descents $D_{Stg} = 4.0$ bis 4.8 dB(A).
- 40) by comparison: sound power level according to RLS-90:
 $L_{W',1h} = L_{m,E} + 19$ dB(A);
 $L_{m,E}$ = source level of one motorcar passing by with $v = 30$ km/h,
 $D_{Stg} = 0$ dB(A) and $D_{Str0} = 0$ dB(A) (correction for different road surfaces
 $\Rightarrow L_{W',1h} = 28.5$ dB(A) + 19 dB(A) = 47.5 dB(A).
- 41) Duration of the impulse sounds when passing over: to average 1.2 sec.
- 42) Point acoustic source in the middle of the ramp ("stepping on the gas" due to the gradient).
- 43) Point acoustic source.
- 44) Gradient of the examined enclosed ramps: 12.2 to 13.7%, cf. RLS-90:
 $D_{Stg} = 4.3$ bis 5.2 dB(A).
- 45) $K_I = L_{WTeq} - L_{Weq}$
- 46) s. fig. 27 and location outline fig. 28.
- 47) Add carry of the value determined for P + R areas.
- 48) not provided security for sufficiently, measurement of one vehicle type only.
- 49) under consideration of literature values (s.sect. 6.1).
- 50) Consideration of additional ambient noises (car radios and conversation of the visitors) on discotheque carports for calculated results "on the safe side".
- 51) For simplification and in order to receive results on the "safe" side, the interior noise level in the "middle of the tunnel" was set also for the determination of the sound power level at the entrance resp. exit opening.
- 52) without acoustically relevant openings.
- 53) One vehicle movement is either an approaching or a leaving movement. One complete process of entering and leaving a carport consists of two movements.
- 54) It is obvious from the tables 4 to 12 where the mentioned values have appeared respectively.

-
- 55) According to observations, in the case of chargeable P + R areas the motion frequencies are considerably lower than in the case of free of charge P + R areas, since especially the job commuters, because of the parking fees, are evading to streets near the station, to the sorrow of the residents.
- 56) The terms "net restaurant room" and "net selling area" are defined in the sect. 3.1.3.
- 57) Discounters or discounting markets, e.g. Aldi, Lidl or Plus, are low price markets with a restricted assortment. In the case of purchase markets with a filling station, in addition motions for the filling station have to be taken into account, s. sect. 5.10.3.
- 58) In the case of hotels with a restaurant with external effect (so-called inns), the sum of the motions of the operation of the dish restaurant and of the operation of the overnight stay business must be taken into account, s. sect.5.8. In the case of hotels near the station (up to a distance of about 1000 m to the station) you can expect only one third of the values given here (cf. table 10).
- 59) with a maximum parking time of two hours.
- 60) Cooling units have to be taken into account, if need be in addition (s. sect. 6.1.2).
- 61) This value has to be taken in the case of purchase markets.
- 62) See 3rd edition of the parking area noise study [30], table 6.
- 63) If the building owner of housing departments is providing more carports than required according to the carport guidelines, correspondingly lower values N can be taken.
- 64) In the case of „open“ underground car park ramps, the garage gate is positioned below the ramp; the sound emission through the open garage gate was negligible at the examined underground car park ramps compared with the driving noise on the ramp.
- 65) The site plans were created using the base data of the Bayerische Vermessungsverwaltung (Bavarian Measurement Administration).
- 66) 1 parking process (= 2 parking movements) = 1 x compressed air
2 x door shutting
1 x starting the engine
1 x standing noise
1x departure
- 67) transferred from the measurement low corridor citybus (no measurement results for the bus "normal").
- 68) transferred from the measurement bus "normal" (no measurement results for the low corridor citybus).

- 69) Details from [30].
- 70) including door banging.
- 71) The term "net selling area", here exclusively explained technically, is not identical with the term "selling area" which is discussed juridically in connection with the application of the Land Utilisation Ordinance [8]. The latter term also comprises the cash area with the room for the bought goods` packing (cf. decision of the Federal Administration Court of 24.11.2005, Az. BVerwG 4 10/04). On the other hand the term "net selling area", used in the parking area noise study, comprises only the total selling area accessible for the purchasers (with shelves, bars, empty areas between) including the area of selling bars, e.g. for meat and sausage products. Not included are the areas of toilets, of the cash area, of the room between cash-desk and entrance resp. exit with packing tables, of compound sites for empties etc. as well as of offices, store rooms and corridors outside the sales room.

Annex 9: Acts, Regulations, Literature

- [1] Gesetz zum Schutz vor schädlichen Umwelteinwirkungen durch Luftverunreinigungen, Geräusche, Erschütterungen und ähnliche Vorgänge (*Federal Immission Control Act* – Bundes-Immissionsschutzgesetz - BImSchG), version of 14.05.1990 BGBl. I p. 180, later on amended plurally.
- [2] Sechste Allgemeine Verwaltungsvorschrift vom 26.08.1998 zum Bundes-Immissionsschutz-Gesetz (*Federal German Noise Regulation* – Technische Anleitung zum Schutz gegen Lärm - TA Lärm), GMBL (1998) no. 26, p. 503.
- [3] Vollzugsbekanntmachung zum Bundes-Immissionsschutzgesetz des Bayer. Staatsministeriums für Landesentwicklung und Umweltfragen of 05.02.1998 (*fulfillment proclamation*).
- [4] Sechzehnte Verordnung zur Durchführung des Bundes-Immissionsschutzgesetzes (*Traffic Noise Protection Regulation* - Verkehrslärmschutzverordnung – 16. BImSchV), 20.06.1990.
- [5] Richtlinien für den Lärmschutz an Straßen – RLS-90 (*Guidelines for the Noise Protection at Roads*), edition 1990, Forschungsgesellschaft für Straßen- und Verkehrswesen.
- [6] Bayerische Bauordnung (*Bavarian Building Regulations* - BayBO).
- [7] Gesetz über Ordnungswidrigkeiten – OwiG, version of 19.02.1987 (BGBl. I p. 602), later on amended plurally (*infringements*).
- [8] Verordnung über die bauliche Nutzung der Grundstücke (*Federal Land Utilisation Ordinance* - Baunutzungsverordnung – BauNVO), version of 23.01.1990 (BGBl. I p. 132), last amended on 22.04.1993 (BGBl. I p. 466).
- [9] E DIN ISO 9613-2 "Dämpfung des Schalls bei der Ausbreitung im Freien"; Teil 2: Allgemeines Berechnungsverfahren, draft version of September 1997.
- [10] E DIN ISO 9613-2 „Dämpfung des Schalls bei der Ausbreitung im Freien“; Teil 2: Allgemeines Berechnungsverfahren, Oktober 1999.
- [11] Empfehlungen für Anlagen des ruhenden Verkehrs – EAR 91, edition 1991, amended reprint 1995, Forschungsgesellschaft für Straßen – und Verkehrswesen (*stationary traffic*).
- [12] Richtzahlen für den Stellplatzbedarf nach der Bek. des Bayer. Staatsministeriums des Innern of 12.02.1978 no. II B 4-9134-79, Ministerialamtsblatt no.6/1978 p.189 (*carport requirement*).
- [13] DIN 18005-1 "Schallschutz im Städtebau – Teil 1: Berechnungsverfahren", May 1987.

- [14] DIN 18005-1 "Schallschutz im Städtebau – Teil 1: Grundlagen und Hinweise für die Planung", July 2002.
- [15] E DIN 45642 "Messungen von Verkehrsgeräuschen", draft version March 1997.
- [16] DIN 45642 "Messungen von Verkehrsgeräuschen", June 2004.
- [17] DIN 45645 Teil 1 "Einheitliche Ermittlung des Beurteilungspegels für Geräuschimmissionen", July 1997.
- [18] VDI 2571 "Schallabstrahlung von Industriebauten", August 1976.
- [19] VDI 3760 "Berechnung und Messung der Schallausbreitung in Arbeitsräumen", February 1996.
- [20] E DIN 45687 "Akustik; Software-Erzeugnisse zur Berechnung der Geräuschimmission im Freien – Qualitätsanforderungen und Prüfbestimmungen", draft version March 2004.
- [21] Allgemeine Verwaltungsvorschrift zum Vollzug des Gaststättengesetzes (GastVwV), Bek. des Bayer. Staatsministeriums für Wirtschaft, Verkehr und Technologie of 25.08.1998 no. 4100-IV/6-32783, AllMBI no. 19/1998 p. 735 (*restaurants*).
- [22] Technischer Bericht zur Untersuchung der Geräuschemissionen von Lastkraftwagen auf Betriebsgeländen von Frachtzentren, Auslieferungslagern, Speditionen und Verbrauchermärkten sowie weiterer typischer Geräusche insbesondere von Verbrauchermärkten, Hessische Landesanstalt für Umwelt und Geologie, 2005 (*noise emissions of trucks on operation centers...*).
- [23] Technischer Bericht zur Untersuchung der Geräuschemissionen und -immissionen von Tankstellen, Hessische Landesanstalt für Umwelt, August 1999 (*noise emissions and immissions of filling stations*).
- [24] Lang, J: "Lärmemissionen von Zu- und Abfahrten zu Tiefgaragen und die lärm-schutztechnisch zweckmäßige Ausbildung", Österr. Zeitschrift für Verkehrswissenschaft, issue 3/91 (*noise emissions of underground car parks*).
- [25] Plank, M.: Schalltechnische Messungen von Einkaufswagen in Standardausführung und gedämmter Ausführung der Wanzl Metallwarenfabrik GmbH, report (not published) of the BEKON GmbH, Augsburg, 07.07.2005 (*shopping trolleys*).
- [26] Probst, W., Huber, B.: Die Berechnung der Schallemission von Parkhäusern, Zeitschrift für Lärmbekämpfung, 5/2000, p. 175-179 (*sound emission of multi-storey car parks*).
- [27] IMMI Version 5; EDV-Programm zur Schallimmissionsprognose, Fa. Wölfel (*computer program for the immission forecast*).

- [28] cancelled.
- [29] Österreichisches Bundesministerium für Wissenschaft und Verkehr, Forschungsarbeiten aus dem Verkehrswesen, Hohenwarther, D.: Geräuschemissionen von Fahrzeugvorbeifahrten, Wien 1997 (*emissions of vehicles passing by*).
- [30] Parkplatzlärmstudie – Untersuchung von Schallemissionen aus Parkplätzen, Autohöfen und Omnibusbahnhöfen (*Parking Area Noise Study*), 3. totally revised edition, Bayerisches Landesamt für Umweltschutz, Schriftenreihe issue 89, 1994.
- [31] Parkplatzlärmstudie – Untersuchung von Schallemissionen aus Parkplätzen, Autohöfen und Omnibusbahnhöfen sowie von Parkhäusern und Tiefgaragen, (*see [30]*), 4. totally revised edition, Bayerisches Landesamt für Umweltschutz, Schriftenreihe issue 89, 2003.
- [32] Schalltechnisches Taschenbuch, H. Schmidt, VDI-Verlag GmbH, Düsseldorf 1989 (*sound engineerings*).
- [33] Hinweise zum Einsatz mechanischer Parksysteme (FGSV-Schriftenreihe no.238), edition 1995, obtainable from FGSV-Verlag, Wesseling Straße 17, D-50999 Köln (*mechanical parking systems*).
- [34] Hinweise zum Fahrradparken (FGSV-Schriftenreihe no. 239), edition 1995, obtainable from FGSV-Verlag, Wesseling Straße 17, D-50999 Köln (*bicycle parking*).
- [35] Hinweise zu Parkleitsystemen – Konzeption und Steuerung (FGSV-Schriftenreihe no. 373), edition 1996, obtainable from FGSV-Verlag, Wesseling Straße 17, D-50999 Köln (*parking guidance systems*).
- [36] Hinweise zu P+R in Klein- und Mittelstädten (FGSV-Schriftenreihe no. 240), edition 1998, obtainable from FGSV-Verlag, Wesseling Straße 17, D-50999 Köln (*P + R areas*).
- [37] Parkplatzlärmstudie - Untersuchung von Schallemissionen aus Parkplätzen, Autohöfen und Omnibusbahnhöfen sowie von Parkhäusern und Tiefgaragen (*see [30]*), 4. totally revised edition, Materialienband: Bewegungs- und Belegungsganglinien, 2001, edited by Büro Möhler + Partner (M + P) by order of the Bayer. Landesamt für Umweltschutz, obtainable from M +P, Paul-Heyse-Str. 27, 80336 München (*motion and occupancy paces*).
- [38] Abschlussbericht zu dem Forschungsvorhaben "Stand der Lärmminderungstechnik bei Fahrzeugen mit lärmrelevanten Zusatzaggregaten – Ladehilfen, Kühl- und Klimaanlage", project no. 105 05 120/05 of FIGE GmbH by order of the Umweltbundesamt, approx. 1986 (*noise of vehicles with aggregates*).

- [39] Geräuschmessungen an speziellen Kraftfahrzeugen; Forschungsinstitut Geräusche und Erschütterungen e.V. (FIGE), Aachen, August 1980 (*noise of special vehicles*).
- [40] Landmann/Rohmer/Hansmann: Umweltrecht II, TA Lärm no. 7, Rdnr. 55; also: Hansmann, Klaus, Dr.: Anwendungsprobleme der TA Lärm, Zeitschrift für Umweltrecht 2002, p. 207 (*environmental law*).

Annex 10: Figures` Dictionary

Figure 1, 2, 3, 4, 5, 6, 7, 8, 9, 10, 11, 12, 13, 14, 15:

Belegung = occupancy
 Bewegungen = motions
 Lkw = truck
 Pkw = motorcar
 Uhrzeit = time of day

Figure 16, 19, 22, 28, 39, 40, 41:

Abfahrt/Anfahrt = leaving/approaching
 Abmessungen = dimensions
 Bewegungen = motions
 ca. = approx.
 Einfahrt/Ausfahrt = approaching/leaving
 Erdgeschoss = ground floor
 Etage = storey
 Fahrgasse = driving lane
 Fahrgeräusche auf Rampe = driving noises on ramp
 Grundriss = horizontal projection
 (Horizontal-)Schnitt = (horizontal) profile
 innen/außen = inside/outside
 Messpunkt = measuring point
 offen/geschlossen = open/closed
 Parkhaus = multi-storey car park
 Parkplatz = parking area
 Regenrinne = rain gutter
 Rolltor = roller gate
 Steigung = gradient
 Stellplatz = carport
 Straße/Str. = street
 Tiefgaragenrampe = underground car park ramp
 über Gelände = above ground
 über GOK = above top edge of ground
 (Vertikal-)Schnitt = (vertical) profile
 Zufahrt = approach
 zwei = two

Figure 17, 18, 20, 24.1-24.3, 25, 29, 35, 36:

Abflussrinne = gutter
 Anfahrt/Abfahrt = approaching/leaving
 Anlasser, anlassen = starter, starting
 Ausfahrt = leaving
 bzw. = resp.
 Druckluft = compressed air
 Einfahrt = entering

Einkaufsmarkt = purchase market
Ein-/Ausparkvorgang = process of entering/leaving a carport
Entfernung zum = distance to the
Feststellbremse = handbrake
Garagentor = garage gate
Knattern = rattling
Leerlauf = idling
Messpunkt = measuring point
Messzeit = measurement duration
Oberfläche = overground
öffnen/schließen = opening/closing
Oktavmittenfrequenz = octavo mid frequency
Parkplatz = parking area
Rangieren = shunting
Schalldruckpegel = sound pressure level
Startvorgang = starting procedure
Taktmaximalpegel = stroke maximal level
Türenschießen = door shutting

Figure 30, 31:

Bau- und Möbelfachmarkt
= market specialized for construction supplies and furniture
Berechnungsformel für den Durchfahranteil
= calculation formula for the passaging traffic share
Bezugsgröße = reference value
Discountmarkt = discounting market
Hinweis: Bei allen Parkplätzen ...
= Information: for all parking areas with the reference value
"carports", the mathematical conversion factor $f = 1$
Netto-Verkaufsfläche = net selling area
Pegelerhöhung durch Durchfahrt
= level increase due to the passaging traffic
Stellplätze (je Bezugsgröße)
= carports (per reference value)
Verbrauchermarkt = consumer market

Figure 32, 33, 34, 38

Abfahrt = departure
Bahnlinie = railway
Einkaufsmarkt = purchase market
Fussgängerunterführung zu den Bahnsteigen
= pedestrian subway to the platforms
insgesamt = altogether
(öffentliche) Straße = (public) street
Stellplätze = carports
Wohnhaus = residential house
Zufahrt = approach